

# 7.1 SURROUND SOUND

CREATIVE



# BLASTER AUDIGY 2 PLATINUM



support for stereo to 6.1 speaker systems



supports 16-bit/48kHz



User Manual

add 2 ports to your PC

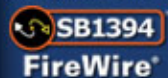





## *How to use this manual*

### Creative Sound Blaster Audigy 2 Platinum

Information in this document is subject to change without notice and does not represent a commitment on the part of Creative Technology Ltd. No part of this manual may be reproduced or transmitted in any form or by any means, electronic or mechanical, including photocopying and recording, for any purpose without the written permission of Creative Technology Ltd. The software described in this document is furnished under a license agreement and may be used or copied only in accordance with the terms of the license agreement. It is against the law to copy the software on any other medium except as specifically allowed in the license agreement. The licensee may make one copy of the software for backup purposes only.

The Software License Agreement is found in a separate folder on this installation CD. The copyright and disclaimer, including trademark issues are also found in the same folder.

**Important:** This User Manual (On CD) has been designed to provide you with complete product knowledge. The following are instructions on how to make use of this manual effectively by launching applications and help files, as well as accessing relevant web sites, where applicable, via specially prepared links.

- To launch applications, Help files or to access relevant web sites, click the **blue text**, or whenever the symbol  or  appears on the object or text.
- For best viewing, this PDF is by default set to "Fit Width" so that all the contents on every page is visible. If you are unable to read the text clearly, press Ctrl + <+> to zoom in or Ctrl + <-> to zoom out. To view full screen, press Ctrl + <L>.

**Note:** To access the applications and Help files, you must first install the manual and the applications in your computer. Otherwise, you will receive error messages. When you click a link to launch a program, a dialog box may appear to inform you that Adobe Acrobat is going to launch the application. Click the **All** button to run subsequent applications without the message appearing again. To access linked web sites, your computer must be connected to the Internet.

CREATIVE

Sound  
BLASTER

AUDIGY2

## Contents



## Contents

### Introduction

High Definition Digital Audio Entertainment.....	ix
What is EAX ADVANCED HD? .....	x
Package Contents .....	xi
System Requirements.....	xii
Sound Blaster Audigy 2 card .....	xii
SB1394/FireWire applications, games, DVD viewing and DVD-Audio	
xii	
Internet Multimedia and Entertainment .....	xiii
Getting More Information.....	xiii
More Help .....	xiii
Technical Support .....	xiii
Document Conventions.....	xiii

### 1 Installing Hardware

What You Need .....	1-1
Your Sound Blaster Audigy 2 Card.....	1-2
Your Joystick/MIDI Bracket .....	1-5
Your Audigy 2 Drive .....	1-6
Connecting Headphones .....	1-8
Connecting Microphones.....	1-9
Adjusting volume-level of Headphones and Microphone.....	1-10
Using the Audigy 2 Drive control knobs .....	1-10
Using Creative Surround Mixer .....	1-11
Using a Remote Control with Your Drive.....	1-11
Remote Control Functions .....	1-12
Installation Steps .....	1-14
Step 1: Prepare your computer .....	1-14
Step 2: Connect the Audigy 2 Drive cables .....	1-16
Step 3: Install the Audigy 2 Drive.....	1-17



Step 4: Install the Sound Blaster Audigy 2 card.....	1-18
Step 5: Install the Joystick/MIDI bracket .....	1-19
Step 6: Connect cables to Sound Blaster Audigy 2 card .....	1-20
Step 7: Connect to power outlet.....	1-22
Connecting Related Peripherals.....	1-23
Connecting Speaker Systems .....	1-26
Connecting External Consumer Devices .....	1-27
Positioning Your Speakers .....	1-29
<b>2 Installing Software</b>	
Installing Drivers and Applications.....	2-1
Sound Blaster Audigy 2 Feature Showcase Demo.....	2-2
Uninstalling and Reinstalling the Applications and Device Drivers ....	2-2
Reinstalling all Audio Drivers and Applications .....	2-2
Uninstalling all Audio Drivers and Applications .....	2-3
Installing/Uninstalling selected Audio Drivers or Applications..	2-4
Using Creative Software AutoUpdate .....	2-5
Updating Windows 2000 (Service Pack 3) .....	2-6
Installing Digital Video Update .....	2-6
<b>3 Using Audigy 2 Software</b>	
Creative Sound Blaster Audigy 2 Applications .....	3-1
Demos.....	3-2
Sound Blaster Audigy 2 Getting Started Demo .....	3-2
Sound Blaster Audigy 2 Feature Showcase Demo.....	3-2
Introduction to the Sound Blaster Audigy 2 software suite .....	3-3
Creative MediaSource Go! .....	3-3
Creative MediaSource Go! Launcher .....	3-3
Creative MediaSource Player.....	3-4
“What-You-Hear” multichannel recording.....	3-4
Creative MediaSource Organizer.....	3-5
Finding and organizing songs .....	3-5



Keep your music database up to date .....	3-5
Transferring songs .....	3-5
Automatically playing multimedia content.....	3-5
Extracting and converting songs.....	3-6
Storing music on recordable CD .....	3-6
Creative MediaSource DVD-Audio Player.....	3-6
Creative EAX Console .....	3-7
Audio Effects: Environmental Sound Processing .....	3-7
CMSS 3D: Simulating Surround Sound.....	3-8
Audio Clean-up: Removing noise and distortion.....	3-8
Time Scaling: Varying the speed of playback .....	3-8
Creative Surround Mixer .....	3-9
Creative Speaker Settings .....	3-9
Creative Speaker Calibrator.....	3-9
Creative MiniDisc Center.....	3-9
Creative SoundFont Bank Manager .....	3-10
Creative Audio Stream Recorder 2.....	3-10
Creative Wave Studio .....	3-11
Diagnostic and troubleshooting utilities.....	3-11
Creative Diagnostics.....	3-11
Creative Speaker Settings .....	3-12



## Appendixes

### A General Specifications

Features .....	A-1
PCI Bus Mastering .....	A-1
Audigy 2 Processor .....	A-1
High Quality Audio Path.....	A-1
Professional Digital Audio Processing.....	A-2
Flexible Mixer Control.....	A-2
THX Certification .....	A-2
Dolby Digital (AC-3) Decoding.....	A-2
Creative Multi Speaker Surround (CMSS) .....	A-3
SB1394/FireWire Compatibility.....	A-3
Connectivity .....	A-3
Sound Blaster Audigy 2 card .....	A-3
Audio Inputs .....	A-3
Audio Outputs.....	A-4
SB1394/FireWire Interfaces .....	A-4
Interfaces.....	A-4
Audigy 2 Drive.....	A-5
Audio/Video Inputs and Outputs On Front Panel.....	A-5
Interfaces.....	A-5

### B Troubleshooting and FAQs

Problems Installing Software .....	B-1
Problems with Sound.....	B-2
Problems with File Transfers on Some VIA Chipset Motherboards....	B-6
Insufficient SoundFont Cache .....	B-7
Problems with Joystick.....	B-8
Problems with Multiple Audio Devices .....	B-9
Problems with Sound Blaster Live! Series or Sound Blaster	



PCI512 card.....	B-10
Resolving I/O Conflicts.....	B-11
Problems with Encore DVD Player .....	B-12
Problems with Software DVD Player .....	B-12
Problems with DV driver for Windows 98 SE/2000/Me/XP .....	B-13
Problems in Windows XP.....	B-14
Problems with Digital Audio Devices .....	B-15



CREATIVE

Sound  
BLASTER

AUDIGY2

## Introduction

# Introduction

---

## High Definition Digital Audio Entertainment

Thank you for purchasing Sound Blaster™ Audigy™ 2 Platinum, the next generation Creative audio product with exciting new features and enhanced audio processing architecture.

This User Manual (on CD) guides you through the installation and usage of Sound Blaster Audigy 2 Platinum. Sound Blaster Audigy 2 Platinum consists of the Sound Blaster Audigy 2 card, Joystick/MIDI bracket, the Audigy 2 Drive and an infrared (IR) remote control.

Featuring 24-bit/192 kHz audio playback, Sound Blaster Audigy 2 Platinum delivers high-definition sound of astounding quality and 24-bit/96 kHz audio recording capability from all Line Ins and SPDIF In. Sound Blaster Audigy 2 Platinum supports surround sound audio on your computer and has output capabilities for 6.1 Dolby® Digital Surround EX.

Sound Blaster Audigy 2 has received the prestigious THX® Multimedia Certification award, making it the perfect choice for PC audiophiles seeking the very best music and movie experiences.

The Sound Blaster Audigy 2 card, with its Audigy 2 processor, enables awesome EAX® ADVANCED HD™ technologies for your gaming and music listening experience. The SB1394™/FireWire® port provides easy high-speed connectivity to NOMAD® portable digital audio players, external CD-RW drives, and other IEEE 1394 compatible devices like DV camcorders, printers, scanners, and digital still cameras.



MLP (Meridian Lossless Packing), the method of audio data compression used in DVD-Audio, reduces file size without removing any of the information that was contained in the original recording. The listening audience will hear the audio as it was intended in the original recording. Other packing methodologies that remove data as part of the compression are referred to as 'Lossy Compression'

Combine Sound Blaster Audigy 2 Platinum with our rich software package for hours of endless fun. Included in your Sound Blaster Audigy 2 Installation and Applications CD are the latest generation drivers and software for you to enjoy DVD-Audio entertainment with native MLP (Meridian Lossless Packing) support, and to create EAX-enhanced MP3 songs, which you can share with your friends over the Internet.

## What is EAX ADVANCED HD?



EAX ADVANCED HD brings a new level of performance, power, and flexibility to PC audio. Taking advantage of the enhanced processing capabilities of the SoundBlaster Audigy 2 processor, EAX ADVANCED HD delivers a host of new features that achieve high definition audio for gaming and music enhancement.

The all-new EAX ADVANCED HD Game Audio Library takes in-game audio and acoustic simulation to a whole new level. These innovative technologies bring tremendous realism and total audio immersion for PC gaming:

- ❑ **New Multi-Environment**<sup>TM</sup> technology renders multiple environment audio effects in real time.
- ❑ **Environment Panning**<sup>TM</sup> makes it easy for gamers to track with three-dimensional precision, the location and movement of sounds that usually represent enemies or team mates. This gives Sound Blaster Audigy 2 gamers a better advantage as they are more "attuned" to the game scenario.
- ❑ **Environment Reflections**<sup>TM</sup> offers localization of early reflections and echoes.
- ❑ **Environment Filtering**<sup>TM</sup> accurately simulates the propagation of sound in both open and closed environments.
- ❑ **Environment Morphing**<sup>TM</sup> allows for seamless transition from one environment to the next.

EAX ADVANCED HD Music Technologies also assures sonic superiority.

- ❑ **Audio Clean-Up** removes unwanted noise in a digital audio file.
- ❑ **Time Scaling** speeds up and slows down music with no distortion.
- ❑ **EAX ADVANCED HD** music effects, developed especially for music listening, further enhance playback of songs.

EAX ADVANCED HD offers dramatically increased 3D audio performance and functionality. Delivering superior audio fidelity and sophisticated reverb effects, this unsurpassed digital entertainment experience is available only from the Sound Blaster Audigy 2 family of products.

## Package Contents



The items listed here may be different in certain countries.



Use the AD\_EXT cable with the Audigy 2 Drive ONLY. Do not attempt to use a conventional IDE cable or any other cable with the Audigy 2 Drive as that may cause electrical shorts and permanent damage to the Audigy 2 card and Audigy 2 Drive, which will void the warranty for this product. Your computer may potentially be damaged too.

The following items are included with the Sound Blaster Audigy 2 Platinum package:

- Sound Blaster Audigy 2 card
- Audigy 2 Drive and IR remote control
- Joystick/MIDI bracket
- Internal SB1394/FireWire cable
- AD\_EXT cable
- Digital CD audio cable
- Power splitter cable
- 2 Mini-DIN-to-standard-DIN adapters
- 3.5 mm minijack to 1/4" plug adapter
- 4 screws + shunt (for microphone selection)
- 2 AAA batteries for the IR remote control
- Sound Blaster Audigy 2 Installation and Applications CD
- Quick Start Guide leaflet
- User manual (on CD)
- Sound Blaster Audigy 2 Feature Showcase Demo CD
- Creative DVD-Audio Sampler disc
- Warranty (printed or on CD)
- Technical Support (printed or on CD)



## System Requirements

### Sound Blaster Audigy 2 card

- ❑ Genuine Intel® Pentium® II 350 MHz, AMD® K6 450 MHz or faster processor
- ❑ Intel, AMD or 100%-Intel compatible motherboard chipset
- ❑ Windows® 98 Second Edition (SE), Windows Millennium Edition (Me), Windows 2000 Service Pack 2 (SP2) or Windows XP
- ❑ 64 MB RAM for Windows 98 SE and Windows Me  
128 MB RAM for Windows 2000 SP2 and Windows XP
- ❑ 600 MB of free hard disk space
- ❑ Available PCI 2.1 compliant slot for the Sound Blaster Audigy 2 card
- ❑ Available adjacent slot for the Joystick/MIDI bracket (optional)
- ❑ Available 5 1/4" PC drive bay
- ❑ Headphones or amplified speakers (available separately)
- ❑ CD-ROM drive installed

### SB1394/FireWire applications, games, DVD viewing and DVD-Audio

- ❑ Genuine Intel Pentium III 500 MHz or AMD 700 MHz processor for SB1394/FireWire applications or games
- ❑ SB1394/FireWire: Minimum 128 MB RAM and 1 GB workspace for digital video (DV) capture and editing. For DV applications, recommended minimum is an Ultra DMA hard disk with 6 GB workspace (ATA-100, 7,200 rpm type)
- ❑ Games: At least 128 MB RAM, a 3D graphics accelerator with at least 8 MB of texture RAM, and 300–500 MB of available free hard disk space
- ❑ DVD: At least second generation DVD-ROM drive with these recommended software players: InterVideo's WinDVD 2000 or CyberLink's PowerDVD 3.0 or later
- ❑ DVD-Audio: Requires genuine Intel Pentium III or AMD Athlon™ 1 GHz or faster, 256 MB for Windows 98 SE, Windows Me, Windows 2000 SP3 and Windows XP SP1, and a second generation DVD-ROM drive 6X or higher



Minimum 256 MB RAM recommended for Windows 2000 SP3 and Windows XP SP1 users for games and DV capture and editing.

## Internet Multimedia and Entertainment

Internet Radio: Requires at least a 56 kbps modem and an active Internet connection to run the application.

Other applications may have higher system requirements or may require a microphone. Refer to the application's online Help documentation for details.

## Getting More Information

Refer to the [Sound Blaster Audigy 2 Getting Started Demo](#) and the various online Help files for detailed information on Creative applications. The [Sound Blaster Audigy 2 Feature Showcase Demo](#) gives you an interactive introduction to Sound Blaster Audigy 2 and demonstrates the card's capabilities.

## More Help

View the contents of the Sound Blaster Audigy 2 Installation and Applications CD for additional libraries and other software. Visit the [www.soundblaster.com](http://www.soundblaster.com) site for the latest Sound Blaster news and products. The site also includes information on making purchases, technical help, and using the Creative Software AutoUpdate for automated driver download and installation.

## Technical Support

Visit [www.soundblaster.com/support/faq](http://www.soundblaster.com/support/faq) for general help.

## Document Conventions

The following typographical conventions are used throughout this manual:



The notepad icon indicates information that is of particular importance and should be considered before continuing.



The alarm clock designates a caution or warning that can help you avoid situations involving risk.



The warning sign indicates that failure to adhere to directions may result in bodily harm or life-threatening situations.

Sound  
BLASTER

AUDIGY2

# 1 Installing Hardware

This chapter tells you how to install the Sound Blaster Audigy 2 Platinum hardware.

# Installing Hardware

## What You Need

Before you begin installation, be sure that you have these:



In addition, you will also need an available PCI slot and another adjacent available slot on your computer.



Use the AD\_EXT cable with the Audigy 2 Drive ONLY. Do not attempt to use a conventional IDE cable or any other cable with the Audigy 2 Drive as that may cause electrical shorts and permanent damage to the Audigy 2 card and Audigy 2 Drive, which will void the warranty for this product. Your computer may potentially be damaged too.

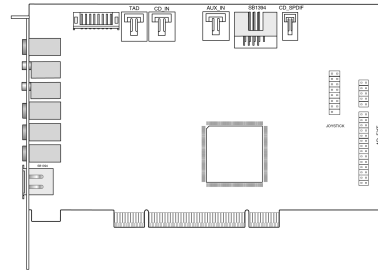

Sound Blaster Audigy 2 card

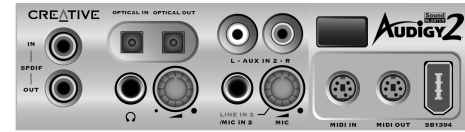

Sound Blaster Audigy 2 Drive

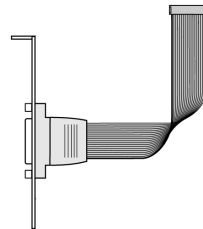

Joystick/MIDI bracket



Digital CD audio cable

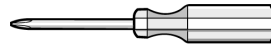

Phillips-head screwdriver (not included)



Remote Control

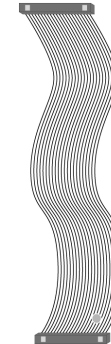

AD\_EXT cable

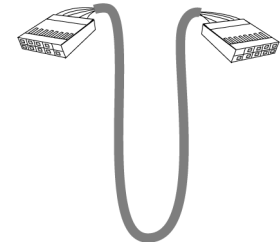

Internal SB1394/FireWire cable



Screws

Shunt



# Your Sound Blaster Audigy 2 Card

Your audio card has these jacks and connectors to enable the attachment of a wide variety of devices:



In Analog mode, the Line Out, Rear Out and Rear Center Out jacks are used simultaneously for 6.1 channel speaker systems.



Click any circled number in the diagram for a description of the item.

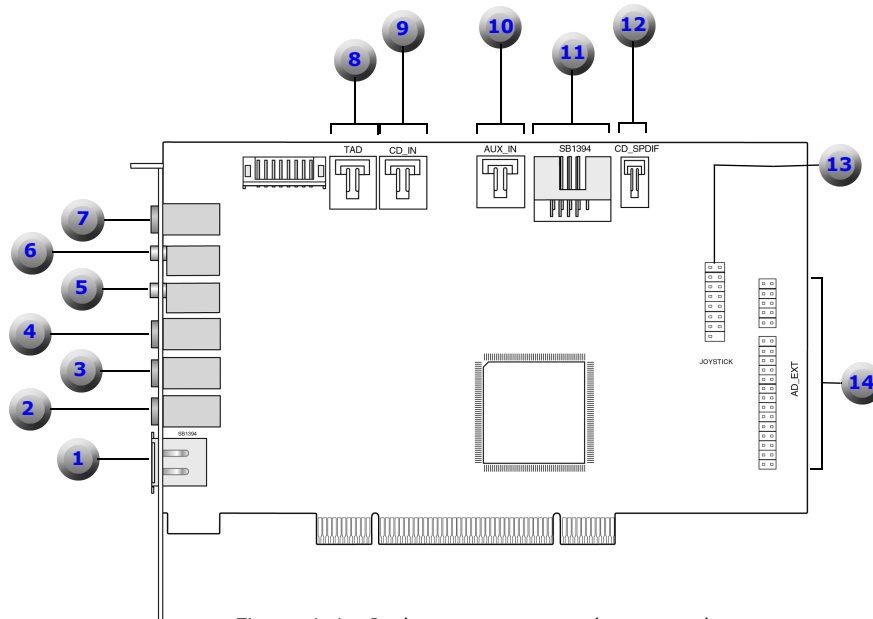

Figure 1-1: Jacks, connectors and ports on the Sound Blaster Audigy 2 card.



Click [here](#) or on any description in the table to return to the main diagram.

**Table 1: Description of Jacks, Connectors and Ports.**

Number	Description
1	<p><b>SB1394/FireWire port (SB1394)</b> Connects to an IEEE 1394 compatible external device (such as a digital video camcorder, digital still camera, printer or scanner).</p>
2	<p><b>Line Out 3 jack (LIN_OUT3)</b> Connects to Center, Subwoofer and Rear Center Out of powered analog speakers or an external amplifier for audio output.</p>
3	<p><b>Line Out 2 jack (LIN_OUT2)</b> Connects to Rear Left/Right Out of powered analog speakers or an external amplifier for audio output.</p>
4	<p><b>Line Out 1 jack (LIN_OUT1)</b> Connects to Front Left/Right Out of powered analog speakers or an external amplifier for audio output. Also supports headphones.</p>
5	<p><b>Microphone In jack (MIC_IN)</b> Connects to an external microphone for voice input.</p>
6	<p><b>Line In jack (LIN_IN)</b> Connects to an external device (such as a cassette, DAT or MiniDisc player).</p>
7	<p><b>Digital Out jack</b> 6-channel or compressed AC-3 SPDIF output for connection to external digital devices or digital speaker systems.</p>

**Table 1: Description of Jacks, Connectors and Ports.**



Click [here](#) or on any description in the table to return to the main diagram.

Number	Description
8	<p><b>Telephone Answering Device connector (TAD)</b> Provides a monaural connection from a standard voice modem, and transmits microphone signals to the modem.</p>
9	<p><b>CD Audio connector (CD_IN)</b> Connects to the Analog Audio output on a CD-ROM or DVD-ROM drive using a CD audio cable.</p>
10	<p><b>AUX In connector (AUX_IN)</b> Connects to internal audio sources such as TV Tuner, MPEG, or other similar cards.</p>
11	<p><b>Internal SB1394/FireWire port</b> Connects to the SB1394/FireWire connector on the Audigy 2 Drive.</p>
12	<p><b>CD SPDIF connector (CD_SPDIF)</b> Connects to the SPDIF (Digital Audio) output (where available) on a CD-ROM or DVD-ROM drive using the Digital CD audio cable provided.</p>
13	<p><b>Joystick/MIDI connector (JOYSTICK)</b> Connects to the Joystick/MIDI cable.</p>
14	<p><b>Audio Extension connector (AD_EXT)</b> Connects to the internal Audigy 2 Drive.</p>

## Your Joystick/ MIDI Bracket

The Joystick/MIDI bracket is used to attach a joystick or MIDI device:

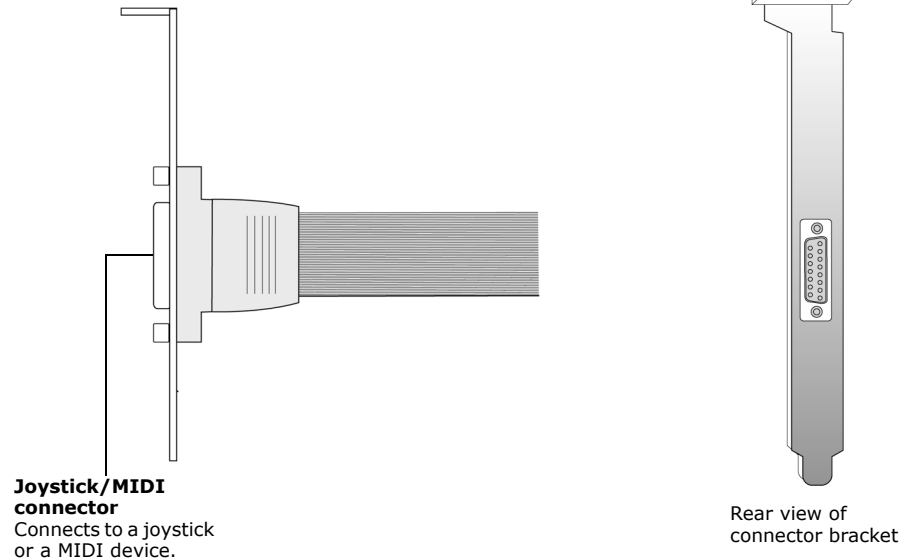

Figure 1-2: Connector on the Joystick/MIDI bracket.

## Your Audigy 2 Drive



Click any circled number in the diagram for a description of the item.



- If your headphones or microphone uses a 1/8" (3.5 mm) plug, use a 1/8" stereo mini plug to 1/4" stereo phono plug adapter (included).
- Set the gain of the Mic In 2 jack to the minimum before connecting or turning on a microphone, especially if you are monitoring the microphone input with headphones.

The Audigy 2 Drive provides additional connectivity for a number of other devices. The front panel of your Audigy 2 Drive has these jacks, connectors and controls:

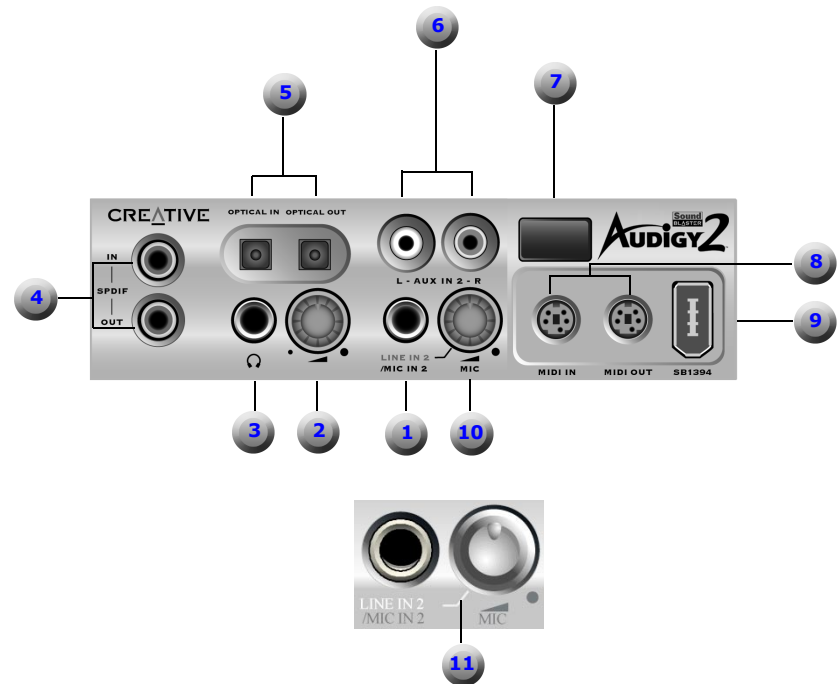

Figure 1-3: Jacks, connectors and controls on the Audigy 2 Drive.



Click [here](#) or on any description in the table to return to the main diagram.

**Table 2: Description of Jacks, Connectors and Controls.**

Number	Description
1	<p><b>1/4" Line In 2/Mic In 2 jack</b> Connects to a microphone or audio devices such as electric guitars and DAT or MiniDisc players.</p>
2	<p><b>Headphone Volume Control</b> Controls the headphones output volume. See "Adjusting volume-level of Headphones and Microphone" on page 1-10.</p>
3	<p><b>1/4" Headphone jack</b> Connects to a pair of headphones using a 1/4" stereo plug or adapter. Your speaker output is muted when you connect the headphones to the Audigy 2 Drive.</p>
4	<p><b>Coaxial SPDIF In/Out jacks</b> Connects to digital audio devices such as DAT and MiniDisc recorders, via RCA input/output.</p>
5	<p><b>Optical SPDIF In/Out connectors</b> Connects to digital audio devices such as DAT and MiniDisc recorders, via optical input/output.</p>
6	<p><b>Auxiliary 2 Line In jacks</b> Connects to consumer equipment such as VCR, TV and CD players, via RCA Auxiliary audio outputs.</p>



Click [here](#) or on any description in the table to return to the main diagram.

**Table 2: Description of Jacks, Connectors and Controls.**

Number	Description
7	<b>Infrared Receiver</b> Receptor for the Infrared commands from your IR remote control.
8	<b>MIDI In/Out connectors</b> Connects to MIDI devices using the mini DIN-to-Standard DIN adapters provided.
9	<b>SB1394/FireWire connector</b> Connects to IEEE 1394 compatible devices.
10	<b>Line In 2/Mic In 2 selector</b> (Microphone Gain Control) To switch to Line In 2, turn the knob counter clockwise over the Line In 2/Mic In 2 separator mark until you hear a "click". To switch back to Mic In 2, turn the knob clockwise over the separator mark until you hear a "click". To increase microphone gain, continue to turn clockwise. See "Adjusting volume-level of Headphones and Microphone" on page 1-10.
11	<b>Line In 2/Mic In 2 separator mark</b>

## Connecting Headphones

There are two types of headphones that can be connected to your Audigy 2 Drive:

- Home or professional headphones fitted with a 1/4" stereo phono plugs.
- Personal stereo headphones fitted with a 1/8" 3.5 mm stereo miniplug, such as those used with personal audio players, when used with the included 1/8" 3.5 mm minijack to 1/4" plug adapter.

## Connecting Microphones



- The Jumper JP1 may not be available on certain models of Audigy 2 Drive.
- The shunt for Jumper JP1 can be found together with the packet of screws provided.

- There are two types of microphones that can be connected to your Audigy 2 Drive:
- ❑ Dynamic microphone, which is usually fitted with a ¼" stereo plug, such as those used in vocal performances.
  - ❑ Condenser microphone, such as those sold for use with computers, are equipped with a 3.5 mm minijack.

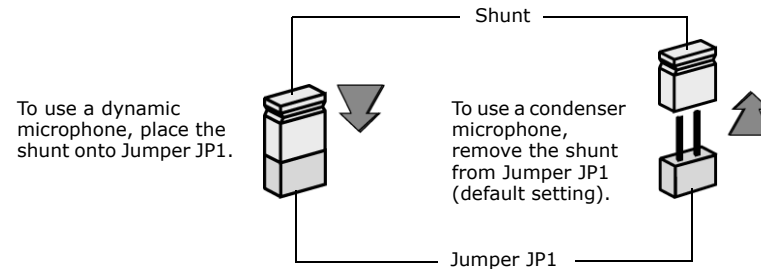

Figure 1-4: Microphone jumper settings.

By default, your Audigy 2 Drive is set for use with a condenser microphone. To use a dynamic microphone, you must place the shunt (jumper) on to Jumper JP1 on your Audigy 2 Drive. See Figure 1-9 on page 1-16 for the location of Jumper JP1 on your Audigy 2 Drive.





## Adjusting volume-level of Headphones and Microphone

You can adjust the loudness of sound produced from your headphones, as well as the gain of your microphone, in two ways.

### Using the Audigy 2 Drive control knobs

On the front panel of the Audigy 2 Drive, turn the respective control knob:

- Counterclockwise** to **decrease** the volume-level of headphones, or microphone gain.
- Clockwise** to **increase** the volume-level of headphones, or microphone gain.

## Using Creative Surround Mixer



To install Surround Mixer and other applications, see "Installing Drivers and Applications" on page 2-1.



- For best effects, set the headphones volume and microphone gain levels to 75% in Creative Surround Mixer, and then use the Audigy 2 Drive's control knobs to make further adjustments.
- If you set the headphones volume or microphone gain levels to 0%, or mute them in Creative Surround Mixer, you hear no sound if the Audigy 2 Drive's control knobs are set to the maximum.

## Using a Remote Control with Your Drive

To adjust the volume-level of headphones:

1. Click **Start -> Programs -> Creative -> Sound Blaster Audigy 2 -> Surround Mixer**.
2. On the **Master Control** panel of Creative Surround Mixer, make sure that there is no red "X" on the **Speaker** button under the **Volume** slider. Otherwise, click the **Speaker** button. This will unmute the audio output to the headphones.
3. Drag the **Volume** slider up or down to adjust the volume-level of headphones.

To adjust microphone gain:

1. Click **Start -> Programs -> Creative -> Sound Blaster Audigy 2 -> Surround Mixer**.
2. On the **Source** panel of Creative Surround Mixer, click an audio input source button with a down arrow, and then select **Microphone**.
3. Make sure the **Speaker** button below the **Microphone** slider has no red "X" on it. Otherwise, click the **Speaker** button. This will unmute the audio input.
4. Drag the slider to adjust the microphone gain.

The Audigy 2 Drive has an infrared receiver for the remote control. This remote control lets you operate your computer from the comfort of your sofa or bed up to a distance of 4 meters (13 feet).

# Remote Control Functions

Refer to Figure 1-5 and Figure 1-6 below for a description of your remote control's functions.



- OSD - On Screen Display.
- Depending on where you purchased your product, the actual remote control may vary from the one shown here.

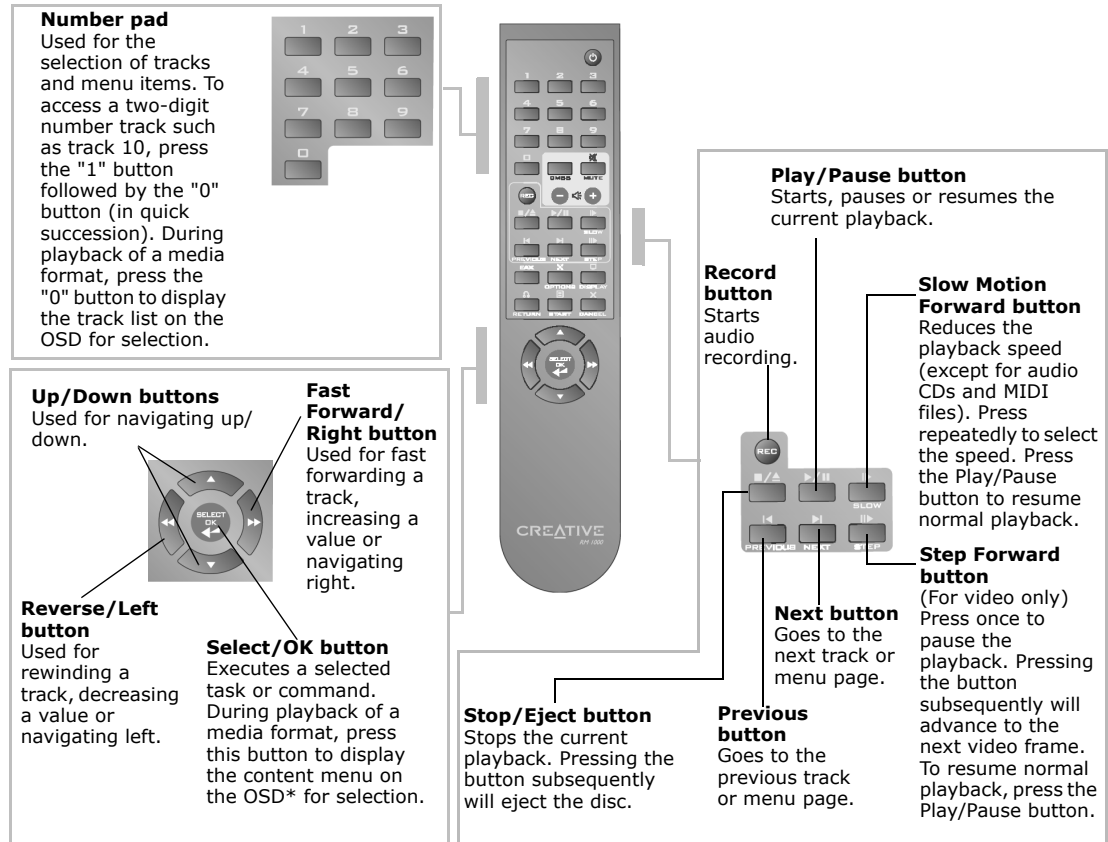

Figure 1-5: Navigation Buttons on the Remote Control.

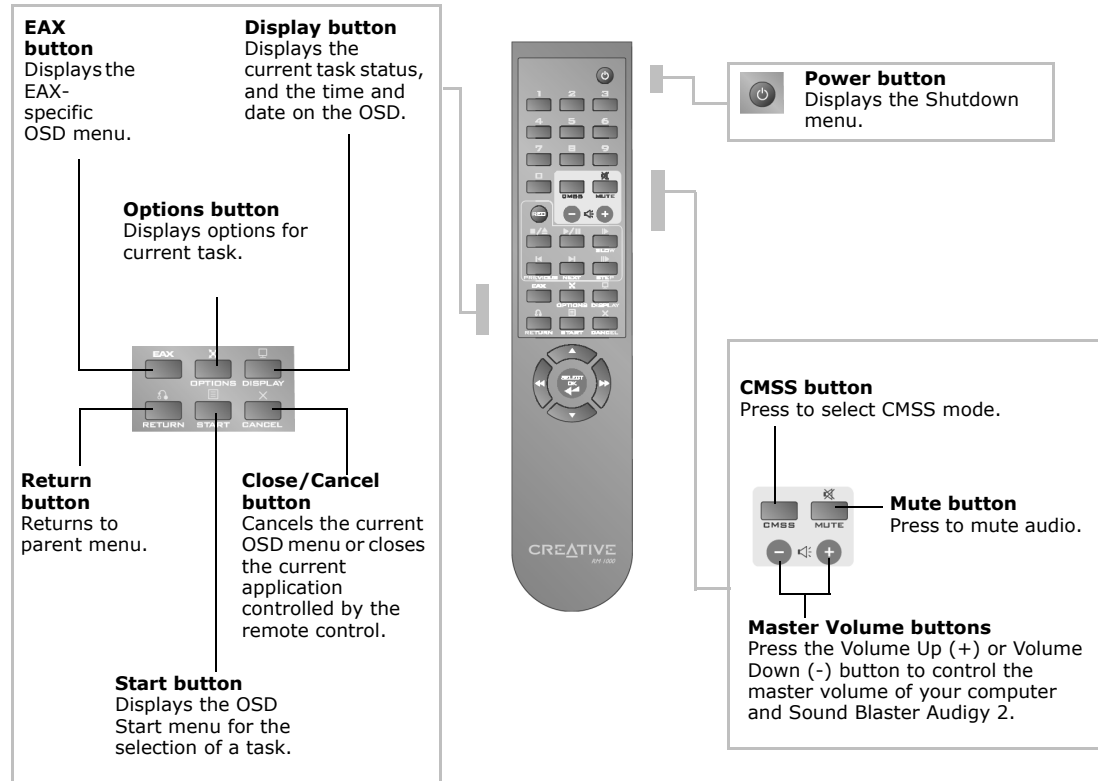

Figure 1-6: Other Buttons on the Remote Control.

## Installation Steps

### Step 1: Prepare your computer



Turn off the main power supply and disconnect your computer's power cord. Systems using an ATX power supply unit with soft power off may still be powering the PCI slot. This can damage your audio card when it is inserted into the slot.



Remove any existing audio card or disable the onboard audio chipset. For more information, see "Problems with Multiple Audio Devices" on page B-9.

1. Turn off your computer and all peripheral devices.
2. Touch a metal plate on your computer to ground yourself and to discharge any static electricity, and then unplug the power cord from the wall outlet.
3. Remove the computer cover.
4. Remove the metal brackets from two adjacent unused PCI slots as shown in Figure 1-7. If the brackets were mounted with screws, put the screws aside for later use in Steps 4 and 5 below.

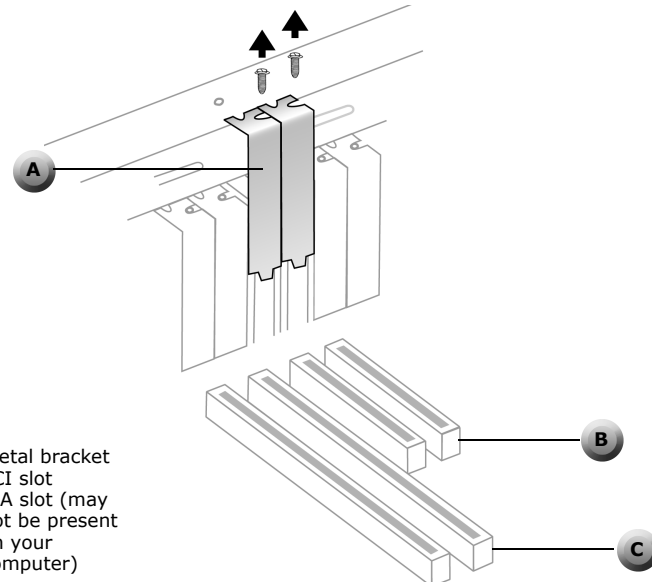

Figure 1-7: Removing metal plates

- To install the Audigy 2 Drive, remove the front panel cover from an unused 5¼" drive bay, as shown in Figure 1-8.

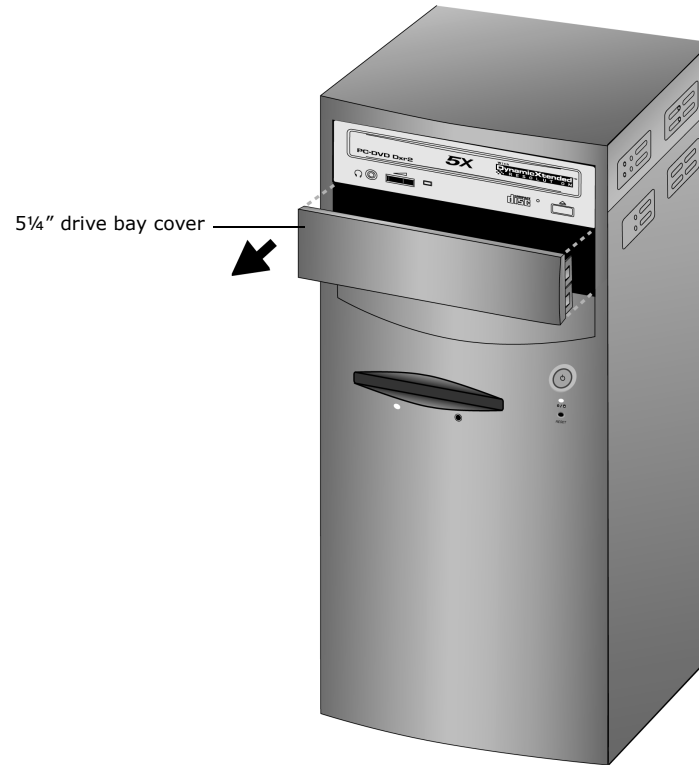

Figure 1-8: Removing 5¼" drive bay cover.

## Step 2: Connect the Audigy 2 Drive cables



- Use the AD\_EXT cable with the Audigy 2 Drive ONLY. Do not attempt to use a conventional IDE cable or any other cable with the Audigy 2 Drive as that may cause electrical shorts and permanent damage to the Audigy 2 card and Audigy 2 Drive, which will void the warranty for this product. Your computer may potentially be damaged too.
- To prevent permanent damage, use only: the AD\_EXT cable with the AD\_EXT connector, and the Audigy 2 card with the Audigy 2 drive.
- Do not force any cable into a connector. This can cause permanent damage to your hardware.

Connect the cables to the Audigy 2 Drive as shown in Figure 1-9.

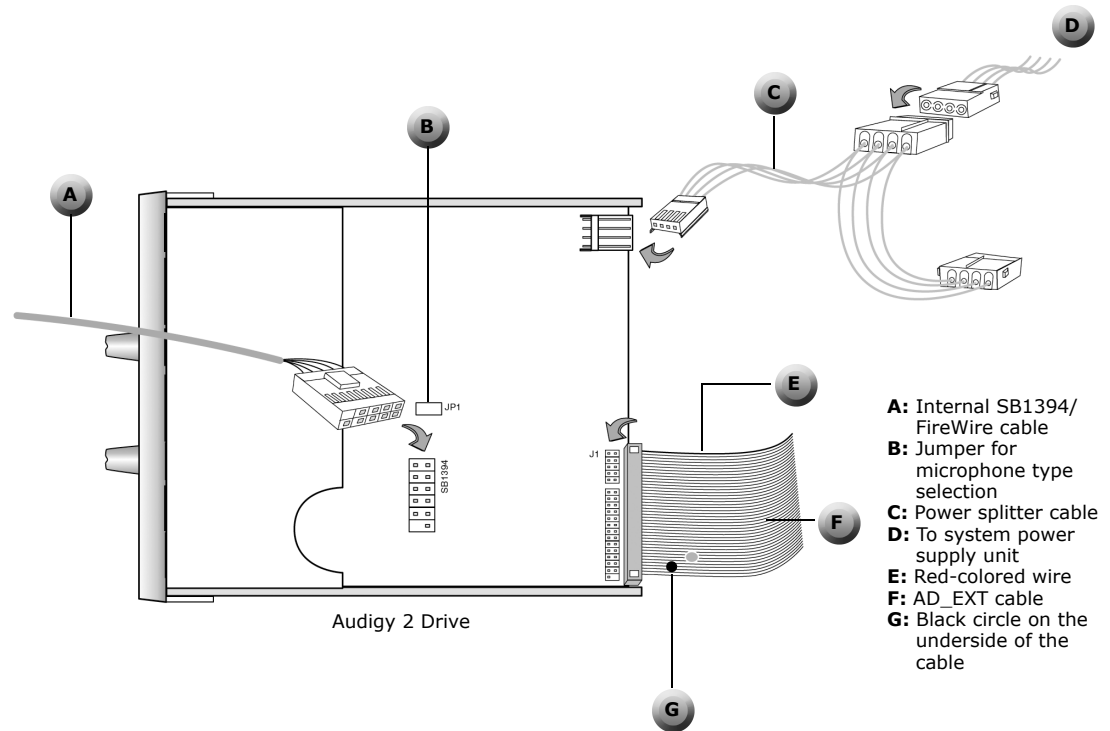

Figure 1-9: Connecting the Audigy 2 Drive cables.

### Step 3: Install the Audigy 2 Drive

1. Slide the Audigy 2 Drive fully into the vacant 5¼" drive bay as shown in Figure 1-10.



Figure 1-10: Installing the Audigy 2 Drive.

2. Secure its sides to the casing with the screws provided.



## Step 4: Install the Sound Blaster Audigy 2 card



Do not force the audio card into the slot. Make sure that the gold finger PCI connector on the Sound Blaster Audigy 2 card is aligned with the PCI bus connector on the motherboard before you insert the card into the PCI expansion slot. If it does not fit properly, gently remove it and try again.

1. Align the Sound Blaster Audigy 2 card with the PCI slot and press the card gently but firmly into the slot as shown in Figure 1-11.

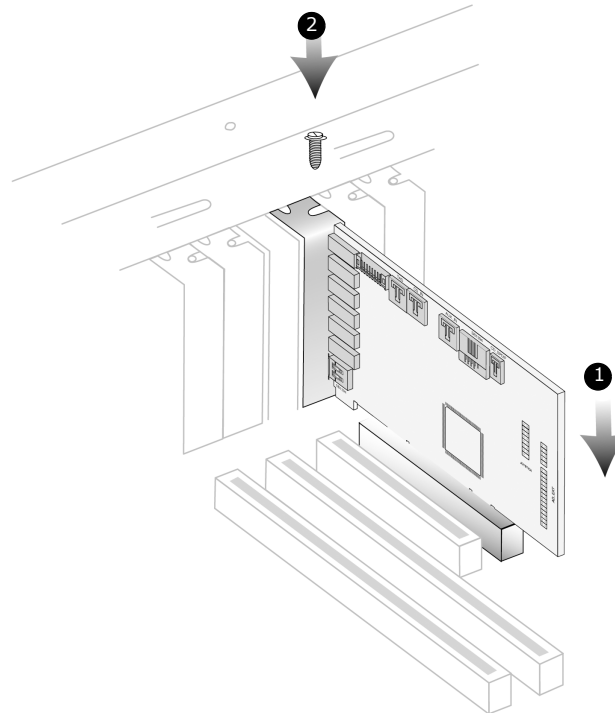

Figure 1-11: Securing the audio card to the expansion slot.

2. Secure the card with a screw if necessary.

## Step 5: Install the Joystick/MIDI bracket



You may also connect all the cables to the Sound Blaster Audigy 2 card first (as shown in "Step 6: Connect cables to Sound Blaster Audigy 2 card" on page 1-20) before securing the card and Joystick/MIDI bracket in place.

If you are installing a joystick or MIDI device (optional), secure the Joystick/MIDI bracket to the slot next to the Sound Blaster Audigy 2 card with a screw if necessary.

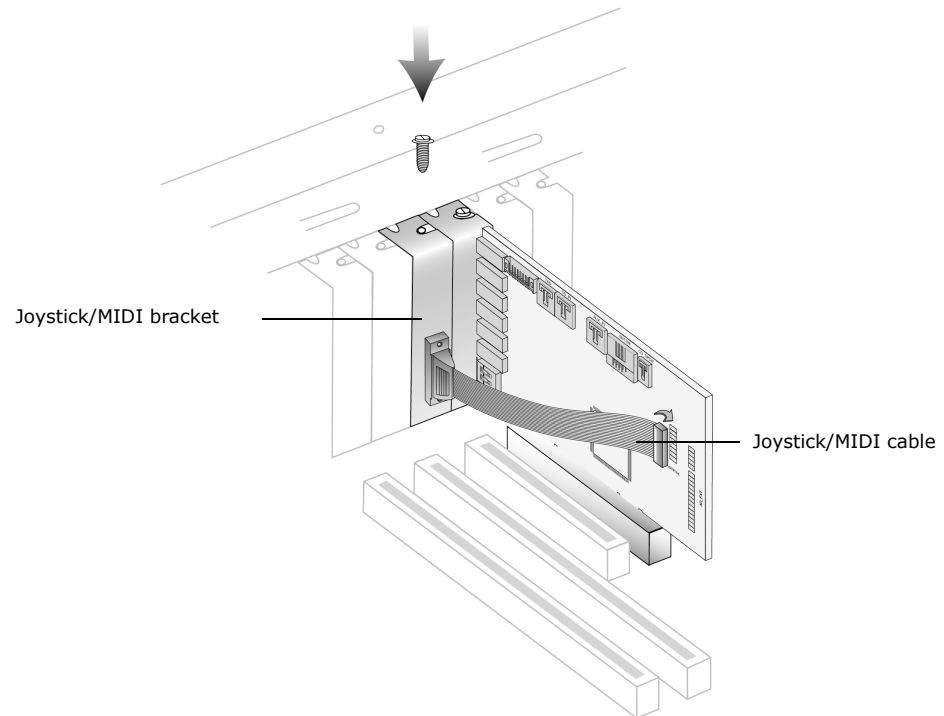

Figure 1-12: Securing the Joystick/MIDI bracket.

## Step 6: Connect cables to Sound Blaster Audigy 2 card



- Use the AD\_EXT cable with the Audigy 2 Drive ONLY. Do not attempt to use a conventional IDE cable or any other cable with the Audigy 2 Drive as that may cause electrical shorts and permanent damage to the Audigy 2 card and Audigy 2 Drive, which will void the warranty for this product. Your computer may potentially be damaged too.
- Align the red-colored wire to Pin 1 of the connector (see Figure 1-13).



You may also connect all the cables to the Sound Blaster Audigy 2 card first (as shown in "Step 6: Connect cables to Sound Blaster Audigy 2 card" on page 1-20) before securing the card and Joystick/MIDI bracket in place.

1. Connect the Joystick/MIDI cable to the Joystick/MIDI connector on the Sound Blaster Audigy 2 card as shown in Figure 1-13.

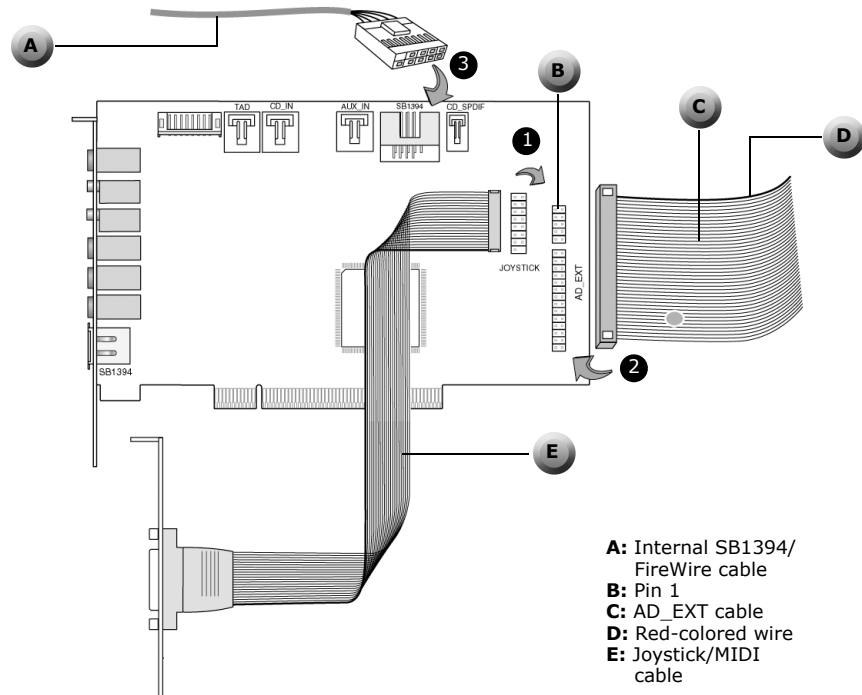

Figure 1-13: Connecting the cables to the Sound Blaster Audigy 2 card.

2. Connect the AD\_EXT cable from the Audigy 2 Drive to the AD\_EXT connector on the Sound Blaster Audigy 2 card.
3. Connect the Internal SB1394/FireWire cable from the Audigy 2 Drive to the Internal SB1394/FireWire port on the Sound Blaster Audigy 2 card.



- If the Sound Blaster Audigy 2 card is connected to both the CD\_SPDIF and CD Audio connectors on a CD-ROM or DVD-ROM drive, do not enable the CD Audio and CD Digital options at the same time in Surround Mixer.
- Analog and Digital CD audio cables are not needed when CDDA is used.
- The CD\_SPDIF connector is not used with software DVD players.

For analog CD audio output:

- ▶ connect an Analog CD audio cable (available separately) from the Analog Audio connector on your CD-ROM/DVD-ROM drive to the CD\_IN connector on the Sound Blaster Audigy 2 card as shown in Figure 1-14.

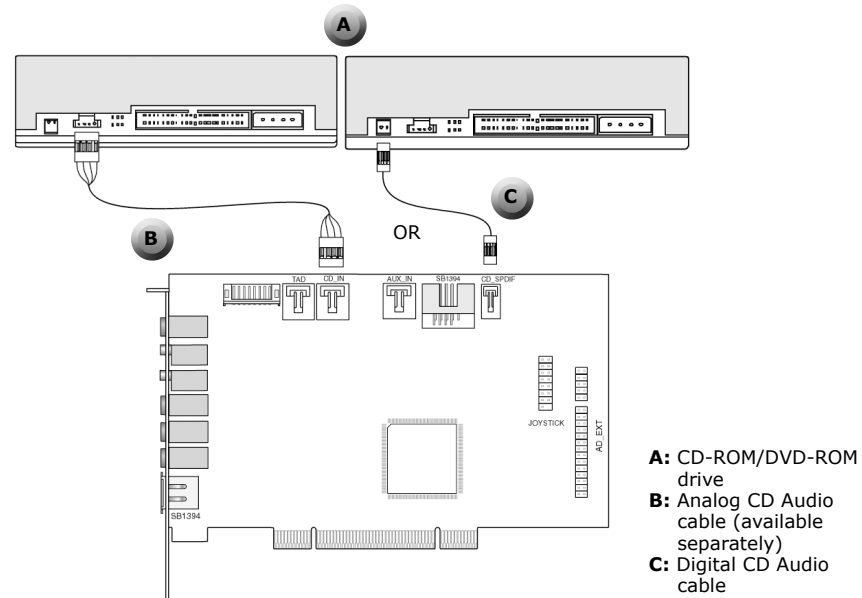

Figure 1-14: Connecting analog/digital audio cables to CD-ROM/DVD-ROM drives.

For digital CD audio output:

- ▶ connect the Digital CD audio cable from the Digital Audio connector on your CD-ROM/DVD-ROM drive to the CD\_SPDIF connector on the Sound Blaster Audigy 2 card as shown in Figure 1-14.



## Step 7: Connect to power outlet

1. Replace the computer cover.
2. Plug the power cord back into the wall outlet, and turn on the computer.

To connect your Sound Blaster Audigy 2 card to other devices, see “Connecting Related Peripherals” on page 1-23.

To install drivers and software, refer to “Installing Drivers and Applications” on page 2-1.

## Connecting Related Peripherals



Use the AD\_EXT cable with the Audigy 2 Drive ONLY. Do not attempt to use a conventional IDE cable or any other cable with the Audigy 2 Drive as that may cause electrical shorts and permanent damage to the Audigy 2 card and Audigy 2 Drive, which will void the warranty for this product. Your computer may potentially be damaged too.



Click any circled number in the diagram for a description of the item.

Sound Blaster Audigy 2 will give you endless hours of listening pleasure. Figure 1-15 shows you how to connect related peripherals to your Sound Blaster Audigy 2 to optimize your enjoyment.

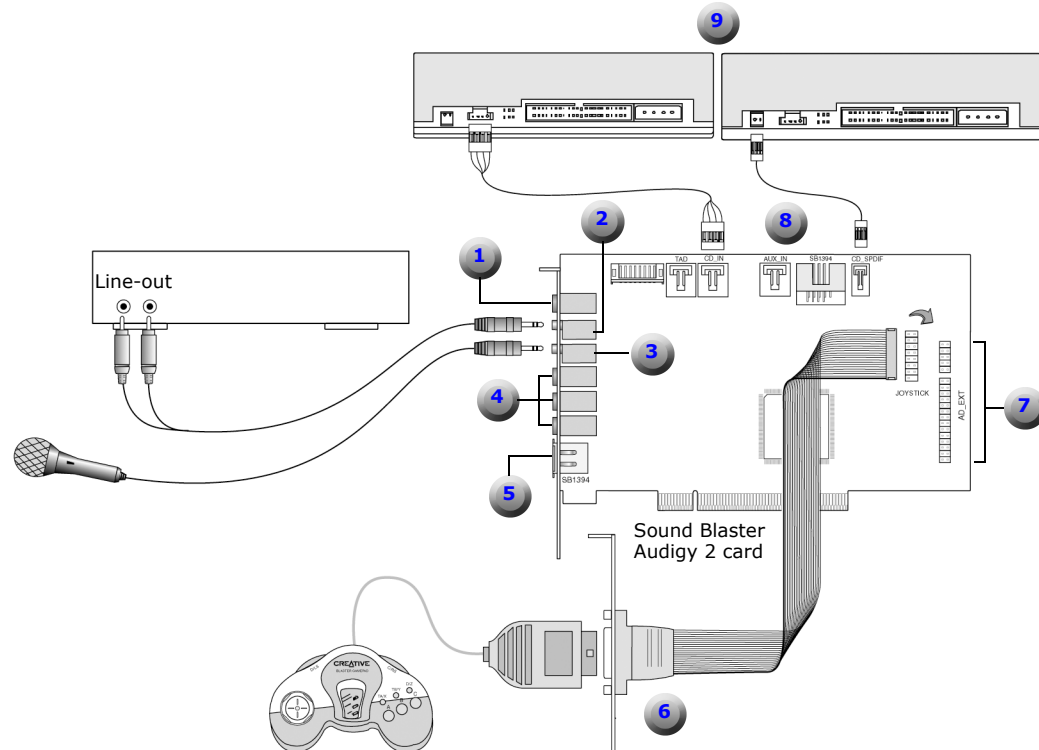

Figure 1-15: Connecting other devices



Click [here](#) or on any description in the table to return to the main diagram.

**Table 3: Description of Connectors and Devices.**

Number	Description
1	<p><b>Digital Out jack</b> Connects to digital speakers, for example, Creative Inspire™ 5.1 Digital Speakers and MiniDisc or DAT via minijack-to-DIN cable.</p>
2	<p><b>Line in</b> Connects to a cassette or CD player, synthesizer, etc.</p>
3	<p><b>Mic in</b> Connects to a microphone.</p>
4	<p><b>Line Out 1 (top), Line Out 2 (middle) and Line Out 3 (bottom)</b> Connects to analog front, rear and rear center inputs of 6-channel speakers, for example, 6.1 Creative Inspire or Cambridge SoundWorks analog speaker systems.</p>
5	<p><b>SB1394/FireWire port</b> Connects to all IEEE 1394 compatible devices such as NOMAD digital audio players, DV camcorders, digital cameras, and WebCams.</p>
6	<p><b>Joystick/MIDI bracket</b> Connects to a game pad or MIDI device like BlasterKey.</p>
7	<p><b>AD_EXT</b> Connects to Audigy 2 Drive.</p>

**Table 3: Description of Connectors and Devices.**

Number	Description
8	<b>Analog CD audio cable*</b> (left) and <b>Digital CD audio cable</b> (right)
9	<b>CD-ROM/DVD-ROM drive</b>



\*Available separately.



Click [here](#) or on any description in the table to return to the main diagram.



# Connecting Speaker Systems

If you have a 5.1 channel speaker system, you can upmix your stereo sources (such as CD Audio, MP3, WMA, MIDI, and Wave) to 6.1 channels by using Creative Multi-Speaker Surround (CMSS) technology. To upmix, you need to enable the CMSS feature in Creative EAX Console. Refer to the Creative EAX Console [online Help](#).

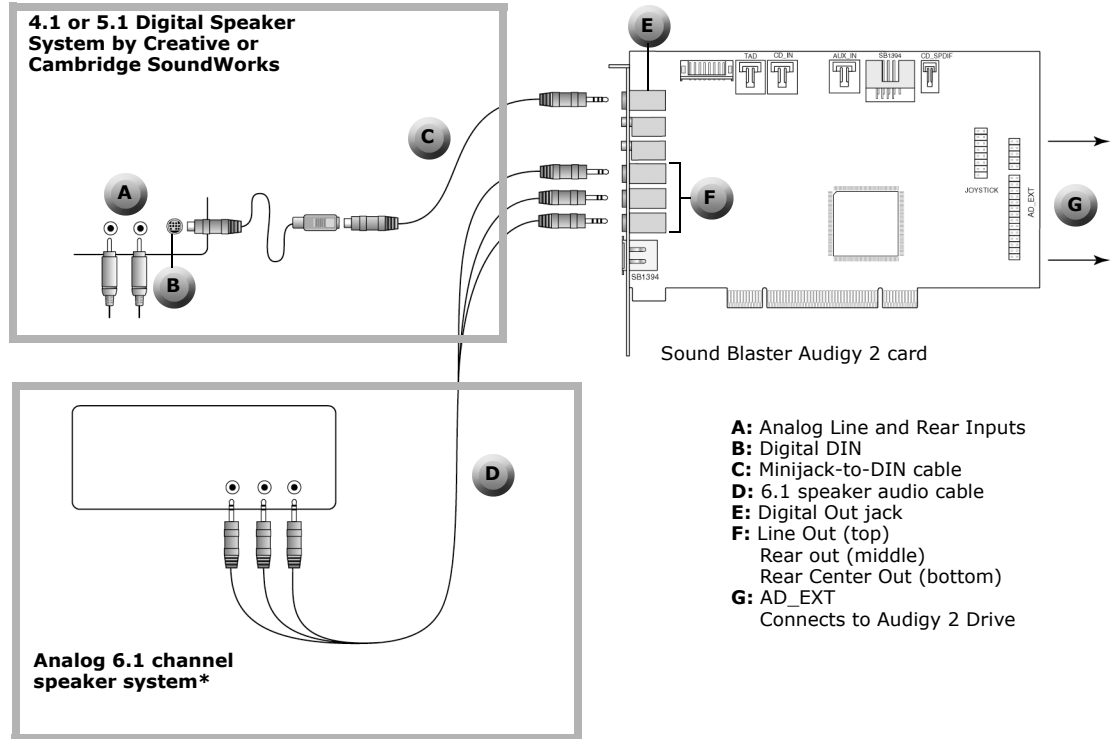

\*For example, Creative Inspire 6.1 Analog Speakers.

Figure 1-16: Connecting Sound Blaster Audigy 2 card to speaker systems.

## Connecting External Consumer Devices



For discrete 7-channel amplifiers or systems, use a 3.5 mm (stereo) Audio/Video-to-RCA cable (not included) to connect Line Out 3 to available center, subwoofer and rear center channels.



Click any circled number in the diagram for a description of the item.

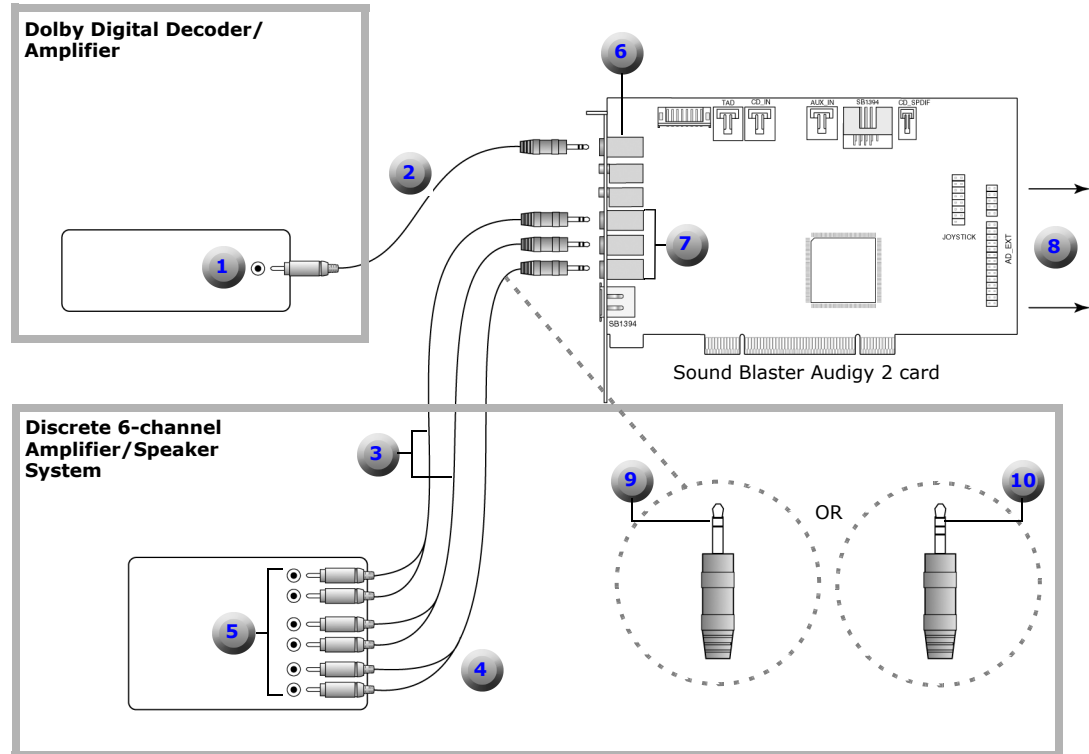

### Additional information for advanced users:

For connection to Center and Subwoofer channels using a 3.5mm (stereo)-to-RCA cable or 3.5 mm (stereo) Audio/Video-to-RCA cable, connect the white RCA jack to the Center input and the yellow/orange RCA jack to the Subwoofer input.

Figure 1-17: Connecting external consumer devices to the Sound Blaster Audigy 2 card.



Click [here](#) or on any description in the table to return to the main diagram.

**Table 4: Description of Connectors and Consumer Devices.**

Number	Description
1	<b>Dolby Digital (AC-3) SPDIF In</b>
2	<b>3.5 mm (mono)-to-RCA cable</b>
3	<b>3.5 mm (stereo)-to-RCA cable</b>
4	<b>3.5 mm (stereo) Audio/Video-to-RCA cable</b>
5	<b>Analog Front, Rear and Center/Subwoofer Inputs</b>
6	<b>Digital Out jack</b>
7	<b>Line Out 1</b> (top) <b>Line Out 2</b> (middle) <b>Line Out 3</b> (bottom)
8	<b>AD_EXT</b> Connects to Audigy 2 Drive
9	<b>3.5 mm (stereo)-to-RCA plug: for 2-channel output, such as, Front Left and Right channels</b>
10	<b>3.5 mm (stereo) Audio/Video-to-RCA plug: for Center (white), Subwoofer (yellow/orange) and Rear Center (red) channels</b>

## Positioning Your Speakers



Good loudspeaker placement can enhance your movie enjoyment, while careless placement can make good audio systems sound bad. For detailed loudspeaker placement tips, visit the Dolby Laboratories web site at [http://www.dolby.com/ht/co\\_br\\_0110\\_ListenersGuideEX.html](http://www.dolby.com/ht/co_br_0110_ListenersGuideEX.html)

If you are using six speakers, place them to form a circle around you (as in Figure 1-18) and angled toward you. Make sure that the computer monitor is not blocking the path of your front speakers. You may want to adjust the relative positions of the speakers until you get the audio experience you like best. If you have a subwoofer, place the unit in a corner of the room for the best bass experience.

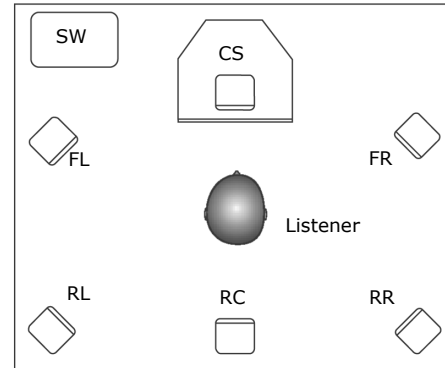

- FL:** Front-left speaker
- CS:** Center speaker
- FR:** Front-right speaker
- RR:** Rear-right speaker
- RC:** Rear-center speaker
- RL:** Rear-left speaker
- SW:** Subwoofer

Figure 1-18: Recommended speaker positions.

Sound  
BLASTER

AUDIGY 2

## 2 Installing Software

This chapter tells you how to install the Sound Blaster Audigy 2 Platinum software.

# Installing Software

---

## Installing Drivers and Applications



- During the installation process, Windows 98 SE users will be prompted to insert the Windows 98 SE installation CD into the CD-ROM drive. Insert the installation CD into the CD-ROM drive and then click the **OK** button.
- Some computers may not be supplied with the Windows 98 SE CD. The necessary files may be found in D:\Windows\Options\Cabs (where D: represents the drive Windows has been installed on).

You need to install device drivers and applications prior to using your Sound Blaster Audigy 2 Platinum. The instructions are applicable to all supported Windows operating systems.

1. After you have installed the Sound Blaster Audigy 2 card and Audigy 2 Drive, turn on your computer. Windows automatically detects the audio card.
2. When prompted for the audio drivers, click the **Cancel** button.
3. Insert the Sound Blaster Audigy 2 Installation and Applications CD into your CD-ROM drive.

If the drive supports Windows AutoPlay mode, the CD starts running automatically. If not, you need to enable your CD-ROM drive's auto-insert notification feature. For more details, see "Problems Installing Software" on page B-1.

4. Follow the instructions on the screen to complete the installation.
5. When prompted, restart your computer.

Downloading the latest applications and device drivers from the Internet is easier than ever with creative Software AutoUpdate. See "Using Creative Software AutoUpdate" on page 2-5 for details.



## Sound Blaster Audigy 2 Feature Showcase Demo

To *feel* the audio card's awesome gaming, music reproduction and home studio capabilities, install the Sound Blaster Audigy 2 Feature Showcase Demo. This demo requires high-quality 5.1/6.1 speaker for optimal listening experience. See "Sound Blaster Audigy 2 Feature Showcase Demo" on page 3-2.

1. Insert the Sound Blaster Audigy 2 Feature Showcase Demo CD into your CD-ROM drive.  
If the drive supports Windows AutoPlay mode, the CD starts running automatically. If not, you need to enable your CD-ROM drive's auto-insert notification feature. For more details, see "Problems Installing Software" on page B-1.
2. Follow the instructions on the screen to complete the installation, and to run the Demo.

## Uninstalling and Reinstalling the Applications and Device Drivers

At times you may need to uninstall or reinstall some or all of the audio card's applications and device drivers to correct problems, change configurations, or upgrade outdated drivers or applications. The following instructions tell you how to do so in all Windows operating systems.

Before you begin, close all audio card applications. Applications that are still running during the uninstallation will not be removed.

## Reinstalling all Audio Drivers and Applications

If you think the audio drivers and applications are corrupted, you may want to reinstall *all* of them. To do so:

1. Click **Start** -> **Settings** -> **Control Panel**.
2. Double-click the **Add/Remove Programs** icon.
3. Click the **Install/Uninstall** tab (*or* **Change or Remove Programs** button).
4. Select the **Sound Blaster Audigy 2** entry, and then click the **Add/Remove** (*or* **Change/Remove**) button.



5. In the **InstallShield Wizard** dialog box, select the **Repair** option.  
If prompted, insert the Sound Blaster Audigy 2 Installation and Applications CD into your CD-ROM, and click the **OK** button.
6. Click the **Yes** button.
7. Restart your computer when prompted.

You can now check the computer to see if the reinstalled software works properly. If not, proceed to "Troubleshooting and FAQs" on page B-1.

## Uninstalling all Audio Drivers and Applications

For a cleaner installation, you may want to uninstall *all* the audio drivers and applications before you reinstall them again. To do so:

1. Click **Start** -> **Settings** -> **Control Panel**.
2. Double-click the **Add/Remove Programs** icon.
3. Click the **Install/Uninstall** tab (*or* **Change or Remove Programs** button).
4. Select the **Sound Blaster Audigy 2** entry, and then click the **Add/Remove** (*or* **Change/Remove**) button.
5. In the **InstallShield Wizard** dialog box, select the **Remove** option.
6. Click the **Yes** button.
7. Restart your computer when prompted.

To uninstall Creative MediaSource and all its components, do the following:

1. Click **Start** -> **Settings** -> **Control Panel**.
2. Double-click the **Add/Remove Programs** icon.
3. Click the **Install/Uninstall** tab (*or* **Change or Remove Programs** button).
4. Select the **Creative MediaSource** entry, and then click the **Add/Remove** (*or* **Change/Remove**) button.
5. In the **InstallShield Wizard** dialog box, click the **Full Uninstallation** button, and then click the **Next** button.
6. Click the **Yes** button.





7. Restart your computer when prompted.

You may now install existing or updated Sound Blaster Audigy 2 Platinum device drivers or applications. For more information, see "Installing Drivers and Applications" on page 2-1.

## Installing/ Uninstalling selected Audio Drivers or Applications

The above instructions help you to install or uninstall all device drivers or applications. However, you can also install or uninstall *selected* drivers or applications.

You may want to install/uninstall a selected audio driver or application. To do so:

1. Click **Start** -> **Settings** -> **Control Panel**.
2. Double-click the **Add/Remove Programs** icon.
3. Click the **Install/Uninstall** tab (*or* **Change or Remove Programs** button).
4. Select the **Sound Blaster Audigy 2** entry, and then click the **Add/Remove** (*or* **Change/Remove**) button.
5. In the **InstallShield Wizard** dialog box, select the **Modify** option.
6. Click the check box of the application that you want to uninstall to clear it.  
If you want to install an application, click the application check box to select it.
7. Click the **Next** button.  
If prompted, insert the Sound Blaster Audigy 2 Installation and Applications CD into your CD-ROM, and click the **OK** button.
8. Restart your computer when prompted.

To uninstall a selected component in Creative MediaSource, do the following:

1. Click **Start** -> **Settings** -> **Control Panel**.
2. Double-click the **Add/Remove Programs** icon.
3. Click the **Install/Uninstall** tab (*or* **Change or Remove Programs** button).
4. Select the **Creative MediaSource** entry, and then click the **Add/Remove** (*or* **Change/Remove**) button.

5. In the **InstallShield Wizard** dialog box, click the **Custom Uninstallation** button, and then click the **Next** button.
6. Click the check box of the application that you want to uninstall to select it.
7. Click the **Next** button.
8. Restart your computer when prompted.

## Using Creative Software AutoUpdate



For your privacy, no personal information is captured by or sent to Creative Labs during the Software AutoUpdate process. Only system information and Creative product details are required for the AutoUpdate analysis. None of this information can or will be used by Creative for any other purpose.

Locating, downloading and installing updates for your Creative products is now simpler and faster with the new web-based Creative Software AutoUpdate system.

Instead of spending valuable time searching for individual files to download and install for each of your installed Creative products, let Creative Software AutoUpdate do the work for you.

When you connect to creative Software AutoUpdate via the Internet, the website will analyze your computer system to determine what operating system (OS), language and Creative products are installed in our system.

After the online analysis, you will be able to select from a list of only the most relevant software and driver updates. The files will then be dynamically retrieved and installed on your system for you. As the files are customized for your specific OS, language and Creative hardware, they are smaller and take less time to download, compared to the huge generic multi-language files available via non-customized software downloads. To find out more about Creative Software AutoUpdate, go to <http://www.soundblaster.com/support/>.

Points to note:

- First-time users of Creative Software AutoUpdate may be prompted to authorize the download of a browser component required for system inspection. Ensure that the content is signed by Creative Labs, Inc., and then click the **Yes** button.
- Ensure that all your Creative products are connected and installed on the same computer running Creative Software AutoUpdate.



## Updating Windows 2000 (Service Pack 3)

Windows 2000 now provides better support for AC-3 SPDIF output (non-PCM through waveOut) for software DVD viewing. Click the web site link below to download the Windows 2000 Service Pack 3 to enjoy this support and to fix other issues in the Windows 2000 OS.

<http://www.microsoft.com>

## Installing Digital Video Update

If you have installed DirectX 8.0 or 8.0a run time, install the latest update for this application. (DirectX 8.1 users do not need the update.)

This update provides PAL support and improved device support to 1394 Digital Video equipment users. This is applicable for Windows 98 SE and Windows 2000 users. This update provides minor improvement to the Windows Me OS. To look for this update, go to the web site below.

<http://www.microsoft.com>

Sound  
BLASTER

AUDIGY 2

## 3 Using Audigy 2 Software

Find out how the software accompanying your audio card can be used to control and customize the card's features for best performance.

# Using Audigy 2 Software

---

## Creative Sound Blaster Audigy 2 Applications



The applications included with Sound Blaster Audigy 2 may differ from those described here. Sound Blaster Audigy 2 may also come with third party applications.

The following software is designed for you to access the basic as well as the advanced features of your audio card. We recommend that you familiarize yourself with their functions in order to make full use of Sound Blaster Audigy 2's rich features.

### **Demos: Providing an overview of Sound Blaster Audigy 2's features**

- Creative Sound Blaster Audigy 2 Getting Started Demo
- Creative Sound Blaster Audigy 2 Feature Showcase Demo

### **Introduction to the Sound Blaster Audigy 2 software suite**

- Creative MediaSource Go!
- Creative MediaSource Go! Launcher
- Creative MediaSource Player
- Creative MediaSource Organizer
- Creative MediaSource DVD-Audio Player
- Creative EAX Console
- Creative Surround Mixer
- Creative Speaker Calibrator
- Creative Speaker Settings
- Creative MiniDisc Center
- Creative SoundFont Bank Manager
- Creative Audio Stream Recorder 2
- Creative Wave Studio

### **Diagnostic and troubleshooting utilities**

- Creative Diagnostics
- Creative Speaker Settings



## Demos

Three demo packages have been included to showcase the basic as well as the advanced features of your Sound Blaster Audigy 2 card. We recommend that you play them at least once in order to have a good overview of your card's features.

### Sound Blaster Audigy 2 Getting Started Demo

This is a good starting point from which you can learn about Sound Blaster Audigy 2. The Sound Blaster Audigy 2 Getting Started Demo consists of several interactive and informative demos that highlight different aspects of Sound Blaster Audigy 2: experiencing digital music and digital gaming, watching movies, connecting speakers, and performing tasks.

### Sound Blaster Audigy 2 Feature Showcase Demo

Use the Sound Blaster Audigy 2 Feature Showcase Demo to *feel* the audio card's awesome gaming, music reproduction, and home studio capabilities.

Experience the following exciting features of the new Sound Blaster Audigy 2:

- ❑ DVD-Audio Playback — Learn more about this new, high-resolution music format and experience the difference when a DVD-Audio clip is being played.
- ❑ EAX ADVANCED HD technologies — Experience complex multi-environment audio effects as you navigate through a fascinating virtual 3D world. Run this demonstration and experience EAX ADVANCED HD technologies such as Environment Panning, Environment Reflection and Environment Morphing. Compare the scenes with and without EAX ADVANCED HD, and you will understand why more game developers are using EAX ADVANCED HD technologies for the best gaming experience.
- ❑ Dolby Digital Surround EX Support — Listen to a THX audio demonstration containing an additional rear channel (rear center) that produces a richer and more consistent surround effect than that of systems with only two rear channels.

**Note:** The Sound Blaster Audigy 2 Feature Showcase Demo can be installed using the Sound Blaster Audigy 2 Feature Showcase Demo CD in your package. This demo will run only if a Sound Blaster Audigy 2 card is installed because the software utilizes the card's hardware capabilities for the demonstrations.



## Introduction to the Sound Blaster Audigy 2 software suite

This section walks you through the main suite of the Sound Blaster Audigy 2 software that enables you to make full use of Sound Blaster Audigy 2's versatile and powerful features.

## Creative MediaSource Go!

Creative MediaSource Go! is a convenient launch pad, not only for Creative MediaSource's components, but also for your own frequently used applications. If you have desktop shortcuts for your favorite applications, you can place them in one central location, Creative MediaSource Go!

The Creative MediaSource Go! button launches Creative MediaSource Go! Launcher. Creative MediaSource Go! floats on your desktop as a small profile bar. Clicking a button on the bar causes it to expand horizontally into a shortcut bar. Creative MediaSource Go! Launcher contains icons that launch the various MediaSource modules for controlling Sound Blaster Audigy 2. You can also add your own shortcut icons to Creative MediaSource Go!.

For more information and usage details on Creative MediaSource Go!, refer to its [online Help](#).

## Creative MediaSource Go! Launcher

Just like the Start button in Windows, Creative MediaSource Go! Launcher provides a single point of access to most of the software programs you need, to control and customize Sound Blaster Audigy 2.

Creative MediaSource Go! Launcher consists of four tabs: **Programs**, **Product Settings**, **Product Support** and **Companion Products**.

- ❑ **Programs** houses shortcuts to Sound Blaster Audigy 2 applications. You can also add your own shortcuts to other applications.



- ❑ **Product Settings** houses shortcuts to specific programs for changing Sound Blaster Audigy 2's hardware settings.
- ❑ **Product Support** contains diagnostic software, product update information, product registration forms, demonstration software as well as helpful documentation such as Getting Started guides.
- ❑ **Companion Products** allows viewing of information on other Creative products and applications.

For more information and usage details on Creative MediaSource Go! Launcher, refer to its [online Help](#).

## Creative MediaSource Player

Creative MediaSource Player is the only software you will need for music and multimedia entertainment. Unlike other media players, Creative MediaSource Player is specially designed to access the power of your Sound Blaster Audigy 2 hardware. With it, you can:

- ❑ play back music and multimedia files: MP3, WAV, WMA, NVF, MLP, VideoCD, etc
- ❑ enhance playback of ordinary music with surround effects using EAX
- ❑ vary the speed of audio playback without affecting the pitch (Time Scaling)
- ❑ use Smart Volume Management to play back a list of songs at a similar volume level even if they were originally recorded at different loudness levels
- ❑ switch between Creative MediaSource Organizer and Creative MediaSource Player with just a click of the mouse
- ❑ use the built-in Creative MediaSource Recorder to record audio (see the section below).

## “What-You-Hear” multichannel recording

Use Creative MediaSource Recorder to record at up to 24-bit/96 kHz from any audio sources processed by the Sound Blaster Audigy 2 card. A multichannel What-You-Hear recording mode lets you capture audio directly from the audio card's 6.1-channel analog speaker outputs, without the need to connect any cables to the Line Out connectors. You can then capture surround-sound movie/gameplay audio, and





even audio content enhanced or upmixed with CMSS and EAX effects. For more information and usage details on Creative MediaSource Player and Recorder, refer to its [online Help](#).

## Creative MediaSource Organizer

Managing a huge collection of audio CDs and MP3 files can be a headache. With Creative MediaSource Organizer, you can find any recording easily, no matter where it is stored on your hard disk or external storage devices. The following is a list of tasks you can perform with Creative MediaSource Organizer.

### Finding and organizing songs

Creative MediaSource Organizer searches your hard disk to compile a database of songs available, called a "PC Music Library" or **PCML**. Once you have a PCML, you can sort it and search for songs. Searching is very fast due to a sophisticated engine and use of three search fields: artist, genre and album.

Once songs have been found, you can create **playlists** to automatically replay them in any desired sequence. You can also enter and edit extra information about each MP3 recording with **ID3** tags.

### Keep your music database up to date

As songs are added or deleted from your computer and other storage devices, your PCML will need to be kept up to date. The Media Sniffer will monitor specified folders on your hard disk for file changes, and update your PCML accordingly.

### Transferring songs

NOMAD users can use Creative MediaSource Organizer to transfer music files to and from the computer and other compatible devices.

### Automatically playing multimedia content

Media Detector makes it easy for users to access multimedia content from various internal or external media. There is no need to hunt through a maze of different software to play different types of files.

Media Detector automatically recognizes the insertion or connection of CDs, VCDs,



and external devices like the NOMAD Jukebox and NOMAD MP3 players. Upon recognition, the content in the media will automatically start playing without further intervention from the user.

## Extracting and converting songs

Storing hundreds of songs on your computer can consume much hard disk space. WAV files and tracks from audio CDs can take up to 50 MB per song. To reduce storage on your hard disk, you can convert tracks from audio CDs into smaller 4 to 5 MB MP3 files. Creative MediaSource Organizer's built-in Rip Now module lets you easily extract tracks from audio CDs, then convert them to MP3 and WMA formats at high resolution bit rates of 320 Kbps and 160 Kbps, respectively.

To eliminate the need for you to manually type the track information of an audio CD's ripped tracks, a feature called Cddb can connect your computer to the Internet (Gracenote's Cddb service) and automatically retrieve the track names and other useful track information for you.

## Storing music on recordable CD

If you have a CD-writer, another way to reduce music storage on your computer's hard disk is to record audio tracks onto CD-R or CD-RW for playback on many consumer hi-fi devices. Creative MediaSource Organizer's Burn CD module lets you create your own audio and MP3 CDs from WAV, MP3 and WMA files. The Burn CD feature also lets you easily design, create, and print matching CD covers and liner notes for your audio CDs.

For more information and usage details on Creative MediaSource Organizer, refer to its [online Help](#).

## Creative MediaSource DVD-Audio Player

Use this application to play back today's highest quality audio recordings available on DVD-Audio discs. You can enjoy 24-bit/96 kHz multichannel surround sound music, or stereo recordings of up to 24-bit/192 kHz resolution. Creative MediaSource DVD-Audio Player requires genuine Intel Pentium III 800 MHz, Windows 98 SE, Windows Me, Windows 2000 SP3 or Windows XP SP1, and a DVD-ROM drive of at least 6X speed.

## Creative EAX Console

EAX Console allows you to configure the Audigy 2 processor's effects engine.

EAX ADVANCED HD promises to deliver sounds that are so life-like, you can almost see them! It is the computer industry's first system to recreate and deliver real-world, interactive audio experiences in games, music, and other audio applications. These audio effects take your computer beyond home-theater quality, immersing you in sound so vivid, your imagination can almost "see" it. The effects go beyond today's surround sound and 3D positional audio, to actually model an environment by taking into account room size, acoustic properties, reverb, echo, and many other effects that create a real-world experience.

EAX Console consists of four sections: **Audio Effects**, **CMSS 3D**, **Audio Clean-up**, and **Time Scaling**.

### Audio Effects: Environmental Sound Processing

In Audio Effects, you can choose how you want to enhance all kinds of ordinary two-channel sounds.

- ❑ **Advanced EQ** lets you boost or de-emphasize the low, mid or high frequencies of sound to suit individual preference and equipment characteristics. Choose various presets like Jazz or Rock to suit the audio characteristics you like best.
- ❑ **Special Effects** let you modify sounds with pre-programmed algorithms so that male voices can be turned into female voices, or human speech turned into "chipmunk talk". You can have lots of fun, especially when communicating over the Internet.
- ❑ **Studio Effects** can add standard distortion, wah, delays and chorus effects to an electric guitar or other musical instrument.
- ❑ **Environmental Effects** simulate typical acoustic environments like stadiums, concert halls, and jazz clubs. By choosing an effect like "concert hall", you can make any music sound like it is being produced inside a concert hall, with all the characteristic echos and reverbration. Various settings let you vary the type of effect, amount of effect applied, and others. If you have connected rear speakers to your computer, EAX will trick your ears into believing that your room has



turned into a concert hall or jazz club. EAX becomes more effective as the number of speakers connected is increased. It supports up to 6 speakers and one subwoofer.

- ❑ **Karaoke Effects** let singers add high-quality echo to add richness to their voices. Users can also vary the music's pitch to suit their vocal range.

### CMSS 3D: Simulating Surround Sound

Creative MultiSpeaker Surround (CMSS) 3D makes ordinary two-channel (Left and Right Stereo) sound seem to surround you, even through only two speakers. For users with 5.1 or 6.1 multichannel speaker systems, CMSS can also simulate surround sound from ordinary stereo. This is useful for watching DVDs and VCDs, which contain only stereo soundtracks.

Select CMSS for multichannel audio enhancement on 4/4.1, 5.1 or 6.1 speaker systems, and CMSS2 for movies.

**Note:** For a 4/4.1-speaker system, audio for your subwoofer is processed by the speaker system.

### Audio Clean-up: Removing noise and distortion

Audio Clean-up allows you to process prerecorded as well as real-time audio, in order to remove noise, click sounds and other artifacts. For example, when recording music from old vinyl records, "click" and "pop" sounds can be removed with the Clean-up feature. The Click Meter informs you whenever the noise clean-up feature is activated during recording and also how many clicks are removed.

### Time Scaling: Varying the speed of playback

Karaoke fans and musicians may sometimes wish to slow a song down (or speed it up) to catch the lyrics or play along with the music. However, varying the speed usually also varies the pitch of the song. With the Time Scaling feature, Sound Blaster Audigy 2 users can maintain the pitch of a song while varying the playback speed.

For more information and usage details on EAX Console, refer to the Creative EAX [online Help](#).

## Creative Surround Mixer

Use Creative Surround Mixer to select the device you wish to listen to or record from. It operates in two possible modes. Click the **Basic Mode** or **Advanced Mode** button to switch between the two modes:

In Basic mode, you can:

- mix sounds from various audio input sources when playing or recording
- control volume, bass and treble

In Advanced mode, you can:

- control balance and vary the loudness ratio between front/rear speakers (fader)
- control the relative loudness levels between Front Center, Rear Center and Subwoofer speakers (if any)

For more information and usage details on Creative Surround Mixer, refer to its [online Help](#).

## Creative Speaker Settings

This is the main application to use for the following tasks:

- Designating the number and configuration of speakers to use
- Testing your speakers
- Activating or deactivating Digital Output
- Managing bass output by selecting subwoofer crossover frequency and volume

## Creative Speaker Calibrator

Creative Speaker Calibrator assists you in optimizing loudspeaker settings and positioning to create much better surround sound and gaming sound effects.

## Creative MiniDisc Center

Creative MiniDisc Center allows you to play back songs on CDs or supported audio formats, and record them to digital recorders such as Digital Audio Tape machines, and also MiniDisc (MD) recorders.

With MiniDisc Center, you can:

- create an album of your favorite songs, each of which may be in a different audio format
- insert a preset period of silence automatically between each track
- play back your personal album and record it to your MD recorder

For more information and usage details on Creative MiniDisc Center, refer to its [online Help](#).

## Creative SoundFont Bank Manager

You can use Creative SoundFont Bank Manager to easily switch between multiple SoundFont banks for performances. This module is optimized to let users quickly audition various presets, reset MIDI devices, or create/modify/save various SoundFont banks from your computer's RAM. Creative SoundFont Bank Manager also switches the Drum Kit on or off at Midi Channel 10.

A virtual keyboard is provided for the user to use the computer's keyboard or mouse to audition SoundFont banks or play musical notes produced through MIDI devices. To edit the presets in the SoundFont banks, use Vienna SoundFont Studio, which you can download from <http://www.SoundFont.com>.

You can use external MIDI input devices to audition your MIDI banks and instruments. First, connect a MIDI input device to your audio card and then select that device in the Creative SoundFont Bank Manager. Once you discover the power of SoundFont technology, you will be amazed at the sound design possibilities available.

For more information and usage details on Creative SoundFont Bank Manager, refer to its [online Help](#).

## Creative Audio Stream Recorder 2

Normally, to listen to a song on the Internet, you need to download the entire file onto your hard disk first — before you can even *hear* the music.

Internet radio stations can, however, make it more convenient for you to enjoy downloaded music: they employ "streaming" technology by which music data flows like a "stream" to your audio card **directly**, *bypassing permanent hard disk storage*.



Thus, the song starts to play as soon as a portion of its data stream has arrived at your audio card. The downside of streaming technology was that you could not record the music onto your hard disk for future reference.

Audio Stream Recorder 2 (ASR2) is designed to overcome this problem by letting you record streaming audio onto your hard disk as standard MP3 or WMA files.

To use ASR2, select from its predefined list of radio stations to listen to. You can click the red Record button to start recording music to your hard disk, or use the Schedule feature to program the computer to record streaming music unattended. You can also use ASR2 to listen to selected radio stations live by clicking the blue Play button.

For more information and usage details on Creative Audio Stream Recorder 2, refer to its [online Help](#).

## Creative Wave Studio

When you need to edit sound files, use Creative Wave Studio. This application supports popular file formats like WAV and AIFF. With Wave Studio, you can convert between file formats and edit out any section of sound. Apply effects like fade-in/fade-out. You can also use it to blend two or more songs into a single file.

For more information and usage details on Creative Recorder, refer to its [online Help](#).

## Diagnostic and troubleshooting utilities

### Creative Diagnostics

Use Creative Diagnostics to quickly test your audio card's Wave, MIDI or CD Audio playback capability, recording function and speaker output. For more information and usage details on Creative Diagnostics, refer to its [online Help](#).



## Creative Speaker Settings

This is the main application to use for managing your speakers and troubleshooting problems related to speaker configurations. See “Creative Speaker Settings” on page 3-9.



Sound  
BLASTER

AUDIGY 2

## **A** General Specifications

This section displays the specifications of your Sound Blaster Audigy 2 card, Joystick/MIDI bracket and Audigy 2 Drive.



# General Specifications

---

This section displays the specifications of your Sound Blaster Audigy 2 card, Joystick/MIDI bracket and Audigy 2 Drive.

## Features

### PCI Bus Mastering

- PCI Specification Version 2.1 compliant
- Bus mastering reduces latency and speeds up system performance

### Audigy 2 Processor

- Advanced hardware accelerated digital effects processing
- 32-bit digital processing, which maintains a 192 dB dynamic range
- Patented 8-point interpolation that reduces distortion to inaudible levels
- 64-voice hardware wavetable synthesizer
- Professional quality digital mixing and equalization

### High Quality Audio Path

- Mixes analog sources such as CD Audio, Line in, Auxiliary, TAD and PC speaker, Microphone in via AC'97 Codec with internal digital sources
- Playback of 64 audio channels, each at an arbitrary sample rate
- 32-bit mixing of all digital sources within Audigy 2's Digital Mixer
- 24-bit Analog-to-Digital conversion of analog inputs at 96 kHz sample rate
- 24-bit Digital-to-Analog conversion of digital sources at 96 kHz to analog 6.1 speaker output
- 24-bit Digital-to-Analog conversion of stereo digital sources at 192 kHz to stereo output
- 16-bit to 24-bit recording sampling rates: 8, 11.025, 16, 22.05, 24, 32, 44.1, 48 and 96 kHz



## Professional Digital Audio Processing

- ❑ Supports Sony/Philips Digital Interface (SPDIF) format of up to 24-bit/96 kHz quality
- ❑ SPDIF output at selectable sampling rate of 48 or 96 kHz
  - Note:** SPDIF output not available during playback of protected digital audio contents authored with DRM (Digital Rights Management) technology
- ❑ Selectable 6-channel SPDIF output to matching digital speaker systems
- ❑ Software switching of SPDIF Input-to-Output (bypass) to minimize cable connection hassle
- ❑ Low latency multitrack recording with ASIO support

## Flexible Mixer Control

- ❑ Software playback control of CD Audio, Line In, Auxiliary, TAD, PC speaker, Microphone In, Wave/DirectSound device, MIDI device and CD Digital (CD SPDIF)
- ❑ Software recording control of Analog Mix (sum of CD Audio, Line In, Auxiliary, TAD, PC speaker) Microphone In, Wave/DirectSound device, MIDI device and CD Digital (CD SPDIF)
- ❑ Selectable input source or mixing of various audio sources for recording
- ❑ Adjustable master volume control
- ❑ Separate bass and treble control
- ❑ Front and rear balance control
- ❑ Muting and panning control for mixer sources

## THX Certification

- ❑ Sound Blaster Audigy 2 has received the prestigious THX<sup>®</sup> Multimedia Certification award, making it the perfect choice for PC audiophiles seeking the very best music and movie experiences.

## Dolby Digital (AC-3) Decoding

- ❑ Decodes Dolby Digital Surround EX to 6.1 or 5.1 channels or pass-through compressed SPDIF bitstream to an external decoder
- ❑ Bass redirection: enhances bass output to subwoofer for small satellite speaker systems



- ❑ Crossover bass frequency (10–200 Hz): adjustable to standalone subwoofer units for desired bass level
- ❑ Adjustable Center, Rear Center and LFE level control

### Creative Multi Speaker Surround (CMSS)

- ❑ Multispeaker technology
- ❑ Upmixes mono or stereo sources to 6.1 channels
- ❑ Professional-quality panning and mixing algorithm

### SBI394/FireWire Compatibility

- ❑ Compliant to IEEE 1394a specification
- ❑ Supports data rates of 100, 200, and 400 Mbps
- ❑ Supports up to 63 IEEE 1394 compatible devices in a daisy-chain configuration
- ❑ Supplies up to 3 watts to IEEE 1394 compatible devices

## Connectivity

### Sound Blaster Audigy 2 card

#### Audio Inputs

- ❑ One line-level analog Line input via stereo jack on rear bracket
- ❑ One mono Microphone analog input via stereo jack on rear bracket
- ❑ CD\_IN line-level analog input via 4-pin Molex connector on card
- ❑ AUX\_IN line-level analog input via 4-pin Molex connector on card
- ❑ TAD line-level analog input via 4-pin Molex connector on card
- ❑ CD\_SPDIF digital input via 2-pin Molex connector on card

## Audio Outputs

- ❑ DIGITAL OUT via 4-pole 3.5 mm minijack on rear bracket
- ❑ Three line-level analog outputs via 3.5 mm minijacks on rear bracket: front, rear, and rear center/center/subwoofer Line-Outs 1, 2 and 3
- ❑ Stereo headphone (32-ohm load) support on Front Line-Out

## SB1394/FireWire Interfaces

- ❑ One 2 x 5 pin Internal SB1394/FireWire connector on card
- ❑ One 6-pin SB1394/FireWire port on rear bracket



The 6-pin SB1394/FireWire connector/port has a 3 watt maximum power output and cannot support more than one high-power device such as an IEEE1394 hard disk or CD-RW drive, unless the other devices are powered independently off AC outlets.

## Interfaces

- ❑ AD\_EXT 2 x 20 pin header for connection to Audigy 2 Drive
- ❑ JOYSTICK 2 x 8 pin header for connection to the Joystick/MIDI connector (optional attachment)



## Audigy 2 Drive

### Audio/Video Inputs and Outputs On Front Panel

- ❑ Two RCA jacks for coaxial SPDIF input and output
- ❑ One headphone output with auto detection via ¼" stereo jack with volume control
- ❑ One shared line-level analog Line/Microphone input (Line In 2/Mic In 2) via ¼" stereo jack. Shared input selectable via switch with gain control for microphone
- ❑ Two mini DIN female connectors for MIDI input and output
- ❑ Two RCA jacks for left and right channel stereo Auxiliary inputs
- ❑ Two optical connectors for optical SPDIF input and output
- ❑ One SB1394/FireWire connector for IEEE 1394 input and output

### Interfaces

- ❑ One 4-pin power supply header for connection to system power supply unit
- ❑ One 2 x 20 pin AD\_EXT header for connection to Sound Blaster Audigy 2 card
- ❑ One Infrared receiver for receiving infrared signals from the remote control
- ❑ One 2 x 5-pin SB1394/FireWire header for connection to the Sound Blaster Audigy 2 card

Sound  
BLASTER

AUDIGY2

## **B** Troubleshooting and FAQs

This section provides solutions to problems you may encounter during installation or normal use.



# Troubleshooting and FAQs

---

This appendix provides solutions to problems you may encounter during installation or normal use.

## Problems Installing Software

### **The installation does not start automatically after the Sound Blaster Audigy 2 Installation and Applications CD is inserted.**

The AutoPlay feature in your Windows system may not be enabled.

*To start the installation program through the My Computer shortcut menu:*

1. Double-click the **My Computer** icon on your Windows desktop.
2. In the **My Computer** window, right-click the CD-ROM drive icon.
3. On the shortcut menu, click **AutoPlay** and follow the instructions on the screen.

*To enable AutoPlay through Auto Insert Notification:*

1. Click **Start** -> **Settings** -> **Control Panel**.
2. In the **Control Panel** window, double-click the **System** icon.
3. In the **System Properties** dialog box, click the **Device Manager** tab and select your CD-ROM drive.
4. Click the **Properties** button.
5. In the **Properties** dialog box, click the **Settings** tab and select **Auto Insert Notification**.
6. Click the **OK** button to exit from the dialog box.

*To start the installation program through Windows Explorer:*

1. In Windows Explorer, browse to the D:\Audio\Setup folder (where D: represents your CD-ROM drive).
2. Double-click the Setup.exe file.





## Problems with Sound

### **There is unexpected excessive environmental sound or effects when an audio file is played.**

The last selected preset is an inappropriate environment for the current audio file.

*To switch to an appropriate environment:*

1. Click the **Audio Effects** tab in EAX Console.
2. Click the **Enable/Disable Audio Effects** check box to clear it.  
**Note:** The preset box title may change, depending on the effect you select.

### **No sound from the headphones.**

*Check the following:*

- The headphones are connected to the Headphones jack.
- In the **Speaker Selection** tab of Creative Speaker Settings, the **Headphones** option is selected in the **Speaker/Headphone Selection** box.
- In the **Basic** tab of Creative Surround Mixer, the recording source selected is **"What U Hear"**.

### **Individual analog recording sources are not displayed in Creative Surround Mixer.**

The following analog recording sources are combined in one recording control called **Analog Mix (Line/CD/TAD/Aux/PC)**, which is found in the **Record** panel of the **Basic** tab:

- Line-In
- CD Audio
- Auxiliary
- TAD-In
- PC Speaker

### **Individual analog recording sources cannot be selected in Creative Surround Mixer.**

Five analog recording sources are combined under the selection **Analog Mix (Line/CD/TAD/Aux/PC)**. For more information, see "Individual analog recording sources are not displayed in Creative Surround Mixer." on page B-2.

*To record an individual analog source:*

- In the **Record** panel of the **Basic** tab in Creative Surround Mixer, make sure the recording source selected is **Analog Mix (Line/CD/TAD/Aux/PC)**.
- In the **Source** panel, mute the analog sources that you do not want to record by clicking the **Speaker** button to change it to a button with a **red cross sign** on it.

### **No sound from the speakers.**

*Check the following:*

- You have connected your speakers to your card's output.
- You have selected the correct source in the **Source** panel of Creative Surround Mixer.
- If both the above conditions have been met and you still do not get any sound, click the **red plus sign** above the **Volume** control and check whether the **Digital Output Only** check box is selected. If it is, you are in the Digital Output Only mode and so must connect to digital speakers to hear the sound from your audio card. See the section on "Speaker Selection Settings" in Creative Speaker Setting's online Help for more information.

### **No audio output when playing digital files such as .WAV, MIDI files or AVI clips.**

*Check the following:*

- The speakers' volume control knob, if any, is set at mid-range. Use Creative Surround Mixer to adjust the volume, if necessary.



To check if your audio card is producing sound, connect a pair of headphones to it. If you hear sound, then the problem is with the speakers or connection; if not, the problem may lie in the card or software configuration.



- ❑ The powered speakers or external amplifier are connected to the card's Line Out or Rear Out jack.
- ❑ There is no hardware conflict between the card and a peripheral device. See "Resolving I/O Conflicts" on page B-11.
- ❑ The Speaker selection in Creative Speaker Settings corresponds to your speaker or headphone configuration.

### **No audio output when playing audio CDs or DOS games that require a CD-ROM.**

*To solve this problem:*

- ❑ Make sure the Analog Audio connector on the CD-ROM drive and the CD In connector on the audio card are connected.
- ❑ Enable digital CD playback:
  - For Windows 98 SE
    - i. Click **Start** -> **Settings** -> **Control Panel**.
    - ii. In the **Control Panel** dialog box, double-click the **Multimedia** icon.
    - iii. In the **Multimedia Properties** dialog box, click the **CD Music** tab.
    - iv. Click the **Enable digital CD audio for this CD-ROM device** check box to select it.
    - v. Click the **OK** button.
  - For Windows Me
    - i. Click **Start** -> **Settings** -> **Control Panel**.
    - ii. In the **Control Panel** dialog box, double-click the **System** icon.
    - iii. In the **System Properties** dialog box, click the **Device Manager** tab.
    - iv. Double-click the DVD/CD-ROM drives icon.  
Your computer drives will appear.
    - v. Right-click the disk drive icon. A menu will appear.
    - vi. Click **Properties**.
    - vii. In the **Digital CD Playback** box of the next dialog box, click the **Enable digital CD audio for this CD-ROM device** check box to select it.



viii. Click the **OK** button.

For Windows 2000 and Windows XP

i. Click **Start -> Settings -> Control Panel**.

ii. In the **Control Panel** dialog box, double-click the **System** icon.

iii. In the **System Properties** dialog box, click the **Hardware** tab.

iv. Click the **Device Manager** button.

v. Double-click the DVD/CD-ROM drives icon.  
Your computer drives will appear.

vi. Right-click the disk drive icon. A menu will appear.

vii. Click **Properties**.

viii. In the **Digital CD Playback** box of the next dialog box, click the **Enable digital CD audio for this CD-ROM device** check box to select it.

### **Panning a source sometimes turns off its sound.**

This occurs when you are in the Digital Output Only mode and the source's left-right balance in a software mixer application other than Creative Surround Mixer (for example, the Windows Volume Control application) is at the opposite end compared to the position to which you have panned the source in the **Basic** tab of Creative Surround Mixer. For example, the CD Audio balance in Windows Volume Control is on the left but in Creative Surround Mixer you have panned the CD Audio to the right.

*To solve this problem:*

Open that other mixer, and center the balances for all the audio input sources. This ensures that your analog sources will not turn silent when you pan them in Creative Surround Mixer.



## Problems with File Transfers on Some VIA Chipset Motherboards

After you install the Audigy 2 card on a VIA chipset motherboard, you may have the slight chance of seeing one of the following:

**When transferring large amounts of data, the computer stops responding ('hangs') or restarts itself, OR Files transferred from another drive are incomplete or corrupted.**

These problems appear in a small number of computers, which contain the VIA VT82C686B controller chipset on their motherboards.

To verify if your motherboard has the VT82C686B chipset:

- Refer to your computer or motherboard manual, or
- In Windows:
  - i. Click **Start** -> **Settings** -> **Control Panel**.
  - ii. Double-click the **System** icon.
  - iii. Click the **Device Manager** or **Hardware** tab.
  - iv. Click the **Systems devices** icon.
  - v. In the list that appears, see if the items highlighted in Figure B-1 appear.
  - vi. If the items appear, remove your computer cover and locate the VIA chipset on your motherboard. (Take note of the safety precautions on page 1-14.)  
The VT82C686B chipset has its model number inscribed on the chip.

If you have the VT82C686B chipset:

- Creative recommends that you first contact your computer vendor or motherboard manufacturer for the latest solution.
- Some users have solved the above problems by doing one or both of the following:

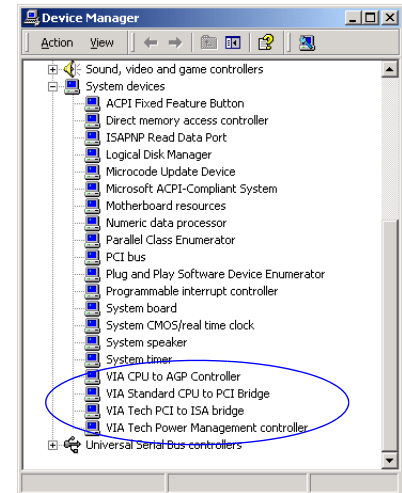

Figure B-1: Device Manager tab.

- downloading the latest VIA 4in1 drivers from <http://www.viatech.com>\*,
- obtaining the most current BIOS for your motherboard from the manufacturer's web site\*.

\*Content in these web sites is controlled by other companies. Creative bears no responsibility for information or downloads obtained from them. This information is provided only as a convenience to you.

## Insufficient SoundFont Cache

### There is insufficient memory to load SoundFont banks.

This may occur when a SoundFont-compatible MIDI file is loaded or played while insufficient memory has been allocated to Creative SoundFont Bank Manager.

To have sufficient SoundFont cache memory:

- Remove one or more SoundFont banks from your SoundFont cache.

Do the following:

- Click the **Bank** button.  
The **Configure Bank** dialog box appears.
  - Click the **Select Bank** drop-down button, and select a bank index.
  - Highlight the bank and click the **Remove** button.
  - Click the **OK** button to finish configuring your banks.
- Load smaller SoundFont banks instead; or add more RAM to your system.

Do one of the following:

- In the **Configure Bank** dialog box of Creative SoundFont Bank Manager, select a smaller SoundFont bank, if available, from the **Select Bank** box.
- Increase the system RAM on your computer. For more details, visit the [www.soundblaster.com](http://www.soundblaster.com) site for technical help.

**Note:** The amount of SoundFont cache you can allocate depends on the system RAM available. Your computer may slow down if the amount of cache used is too high.



The trade-off of a smaller SoundFont file is its lower sound quality.

## Problems with Joystick

### The joystick port is not working.

The audio card's Joystick/MIDI connector may be conflicting with the system's joystick port.

*To solve this problem:*

Disable the audio card's Joystick/MIDI connector and use the system port instead. Do the following:

1. Click **Start** -> **Settings** -> **Control Panel**.
2. In the **Control Panel** window, double-click the **System** icon.
3. In the **System Properties** dialog box, click the **Device Manager** tab.
4. Double-click **Sound, Video And Game Controllers**, and then select **Creative Audigy 2 Gameport (Creative Game Port for Windows 2000)**.
5. Click the **Properties** button.
6. In the Properties dialog box:
  - If you have an **Original Configuration (Current)** check box:
    - Clear the check box to disable it.
  - If you have a **Disable In This Hardware Profile** check box:
    - Make sure that the check box is selected to disable it.
7. Click **OK** to restart Windows and for the change to take effect.

When the Gameport Joystick interface is disabled, the entry in Device Manager has a red cross.

### The joystick is not working properly in some programs.

The program may use the system processor timing to calculate the joystick position. When the processor is fast, the program may determine the position of the joystick incorrectly, assuming that the position is out of range.



Do not attempt to make changes to the BIOS unless you have experience with system software.



*To solve this problem:*

Increase your system's 8 bit I/O recovery time of the BIOS setting, usually under the Chipset Feature Settings section. Or, if available, you may adjust the AT Bus speed to a slower clock. If the problem persists, try a different joystick.

## Problems with Multiple Audio Devices

### **The other installed audio card is not working well.**

You may have an existing audio device installed in your computer. The audio device may be an audio card or an onboard audio chipset. Before you install your Sound Blaster Audigy 2 card, you are advised to completely uninstall and remove your existing audio device. Operating multiple audio devices in your computer may introduce usability issues.

*Alternatively, during the installation of your Sound Blaster Audigy 2 card, do the following:*

- If your computer detects an installed Sound Blaster Live! Series or Sound Blaster PCI512 audio card, a message box recommending that you completely uninstall and remove the older audio device will appear. Click the **Yes** button and follow the instructions on the screen to complete the removal of the old audio device. Remove the old audio card from your computer.
- If your computer detects any other installed audio card, a message box recommending that you completely uninstall and remove the older audio device will appear. Click the **Yes** button to continue with the installation of the Sound Blaster Audigy 2 card.

After the installation of the Sound Blaster Audigy 2 card, completely uninstall the existing card and remove the audio card from your computer.

### **The onboard audio chipset is not working well.**

*To disable an onboard audio chipset, do the following:*

1. Restart your system.





2. During the memory check, press <F2> or <Delete>, depending on your motherboard.  
The BIOS setup menu appears.
3. Select **Chipset Features Setup** and press <Enter>.
4. Select **Onboard Legacy Audio** and press <Enter> to disable your onboard audio chipset.
5. Press <Esc> to return to the BIOS setup menu.
6. Select **Save & Exit Setup**, and then press <Enter>.
7. Press <Y> and then press <Enter>

## Problems with Sound Blaster Live! Series or Sound Blaster PCI512 card

### **Sound Blaster Live! or Sound Blaster PCI512 applications are not working.**

Other than normal playback and recording functions, older audio devices may not work well when Sound Blaster Audigy 2 is installed.

*To solve this problem:*

Uninstall and remove the older card from the computer. Otherwise, you can choose to disable the Sound Blaster Live! or Sound Blaster PCI512 card:

1. Click **Start** -> **Settings** -> **Control Panel**.
2. In the **Control Panel** window, double-click the **System** icon.
3. In the **System Properties** dialog box, click the **Device Manager** tab.
4. Double-click **Sound, Video And Game Controllers**, and then select **Creative Sound Blaster Live! Series** or **Creative Sound Blaster PCI512**.
5. Click the **Properties** button.
6. In the Properties dialog box:
  - If you have an **Original Configuration (Current)** check box:
    - Clear the check box to disable it.
  - If you have a **Disable In This Hardware Profile** check box:
    - Make sure that the check box is selected to disable it.

7. Click **OK** to restart Windows and for the change to take effect.

When the Sound Blaster Live! series is disabled, the entry in Device Manager has a red cross.

## Resolving I/O Conflicts



You can also refer to the Troubleshooting section in the online Help of Windows 98 SE/Me.

Conflicts between your audio card and another peripheral device may occur if your card and the other device are set to use the same I/O address.

To resolve I/O conflicts, change the resource settings of your audio card or the conflicting peripheral device in your system using Device Manager in Windows 98 SE/Me.

If you still do not know which card is causing the conflict, remove all cards except the audio card and other essential cards (for example, disk controller and graphics cards). Add each card back until Device Manager indicates that a conflict has occurred.

*To resolve hardware conflicts in Windows 98 SE/Me:*

1. Click **Start -> Settings -> Control Panel**.
2. In the **Control Panel** window, double-click the **System** icon.
3. In the **System Properties** dialog box, click the **Device Manager** tab.
4. Under the Sound, Video And Game Controllers entry, select the conflicting audio card driver—indicated by an exclamation mark (!)—and click the **Properties** button.
5. In the Properties dialog box, click the **Resources** tab.
6. Make sure that the **Use automatic settings** check box is selected, and click the **OK** button.
7. Restart your system to allow Windows 98 SE/Me to reassign resources to your audio card and/or the conflicting device.



## Problems with Encore DVD Player

**The Encore DVD Player is not launched when a DVD disc is inserted into the drive.**

*To solve this problem:*

1. In the Windows system tray, right-click the Disc Detector icon, and then click **Properties**.
2. On the **General** tabbed page of the **Creative Disc Detector** dialog box, make sure that the **Enable Disc Detector** check box is selected.
3. Click the **Players** tab.
4. Select the DVD Disc entry and then click the **Select Player** button.
5. In the **Players Properties** dialog box, click the **Browse** button.
6. Locate and select D:\Program Files\Creative\PC- DVD Encore (where D: represents your CD-ROM drive) and double-click the entry **ctdvdply**. The **Name** box now displays the entry *ctdvdply*.
7. Click the **OK** button twice.

## Problems with Software DVD Player

**Changing audio configuration (for example, switching from multichannel mode to SPDIF Output mode or vice versa) while watching a DVD movie does not seem to work, even though all settings in the software DVD player and in Creative Surround Mixer are correct.**

*To solve this problem:*

Close and restart the software DVD player.

## Problems with DV driver for Windows 98 SE/2000/Me/XP



The 1394 DVConnect driver does not run on Windows XP.

### The DV camcorder is not working properly.

The MSDV camcorder driver may not be the latest version (v4.10.2226).

*To solve this problem:*

1. Visit [www.Microsoft.com](http://www.Microsoft.com) and download the Digital Video update for the DirectX 8.0 file (dx80bda.exe).
2. Install the above file into your computer.

**Note:** You need to install DirectX 8.0 or 8.0a run time first.

If the problem still persists, the MSDV camcorder driver may not be fully optimized for your DV camcorder.

*To solve this problem:*

1. Turn on your DV camcorder.
2. Insert the Sound Blaster Audigy 2 Installation and Applications CD into your CD-ROM drive.  
Exit from the welcome screen.
3. Using Windows Explorer, locate the **1394** folder in the CD-ROM, and run the DVConnect 240.exe file. Follow the instructions on the screen to complete the setup.  
If you are in Windows 98 SE, you may be prompted to insert the Windows 98 SE CD-ROM first. Follow the instructions on the screen to complete this setup.
4. Click the **Finish** button.
5. Turn off and then turn on your DV camcorder.

## Problems in Windows XP

**A Hardware Installation error message appears on a Windows XP operating system when non-Creative applications are being installed.**

At the time of this product's release, Microsoft strongly encouraged companies to submit their hardware solutions for certification. If a hardware device driver is not submitted, or does not qualify, for Microsoft certification, a warning message similar to the one below appears.



You may see the message when you install hardware drivers from companies other than Creative. If you do, you may choose to click the **Continue Anyway** button. Device drivers not signed by Microsoft may be used in Windows XP, and need not impair or destabilize your computer.

Should you need more XP-related information or help, you can contact the company that developed the driver, at the company's web site or helpline.

## Problems with Digital Audio Devices

### **Intermittent hissing or no sound is heard from my digital speakers.**

Make sure you select the sampling rate of the PCM SPDIF output of your Digital Out connector to match the requirements of the receiving device. You may need to select a lower digital output sampling rate. The choices available are 48 kHz and 96 kHz.

*To solve this problem:*

1. In Creative MediaSource Go! Launcher, click the **Product Settings** tab.
2. Double-click the **Device Controls** icon.
3. Click the **Sampling Rate** tab.
4. Click the required sampling rate from the **Digital Output Sampling Rate** list.

### **Popping noises is heard during playback.**

Check that the DMA feature is selected for all drives.

*To solve this problem:*

For Windows 98 SE and Windows Me:

1. Click **Start -> Settings -> Control Panel**.
2. In the **Control Panel** dialog box, double-click the **System** icon.
3. In the **System Properties** dialog box, click the **Device Manager** tab.
4. Double-click the **Disk drives** icon.  
Your computer drives will appear.
5. Double-click the hard disk drive icon.
6. In the box that appears, click the **Settings** tab.
7. Click the **DMA** (direct memory access) check box to select it.  
An alert message box appears.
8. Click the **OK** button.
9. Click the **OK** button in the next box.
10. Click the **Close** button on the **System Properties** dialog box.



If you have installed Intel Application Accelerator version 1.1.2 in your computer, DMA may be automatically selected on all your drives.



11. When prompted to restart your computer, click the **Yes** button.
12. Repeat steps 4-11 if you have other drives, for example, other hard disk drives, CD-ROM, CD-RW, and DVD-ROM drives. In step 4, double-click the respective drive icon.

For Windows 2000 and Windows XP:

1. Click **Start -> Settings -> Control Panel**.
2. In the **Control Panel** dialog box, double-click the **System** icon.
3. In the **System Properties** dialog box, click the **Hardware** tab.
4. Click the **Device Manager** button.
5. Double-click the **ATA/ATAPI IDE Controllers** icon.  
Your IDE channels will appear.
6. Right-click the **Primary IDE Channel** icon.
7. Click **Properties**.
8. In the **Properties** dialog box, click the **Advanced Settings** tab.
9. Click the **DMA if available** check box to select it.
10. Click the **OK** button.