

MB800

Pentium 4 Intel 845G
Industrial Motherboard

USER'S MANUAL

Version 1.0B

Acknowledgments

Award is a registered trademark of Award Software International, Inc.

PS/2 is a trademark of International Business Machines Corporation.

Intel and Pentium 4 are registered trademarks of Intel Corporation.

Microsoft Windows is a registered trademark of Microsoft Corporation.

Winbond is a registered trademark of Winbond Electronics Corporation.

All other product names or trademarks are properties of their respective owners.

Table of Contents

Introduction.....	1
Product Description	1
Checklist.....	2
Specifications.....	3
Board Dimensions.....	4
Installations	5
Installing the CPU.....	6
ATX Power Installation	7
MicroPCI Daughter Card Installation	7
Installing the Memory	8
Setting the Jumpers.....	9
Connectors on MB800.....	13
Watchdog Timer Configuration.....	29
BIOS Setup.....	29
Drivers Installation.....	51
Intel Chipset Software Installation Utility	52
Intel 845G Chipset Graphics Driver Installation	55
Intel Application Accelerator Installation	57
Sigmatel AC97 Codec Audio Driver Installation	61
Intel PRO LAN Drivers Installation.....	63
Appendix	65
A. I/O Port Address Map	65
B. Interrupt Request Lines (IRQ)	66

This page is intentionally left blank.

Introduction

Product Description

The world's first Pentium 4 industrial motherboard, MB800, is based on the Intel 845G chipset. It packs the key features of the 845G chipset, including 533MHz processor side bus and integrated LAN and graphics. The 845G chipset includes Intel's new ICH4 I/O control hub that supports USB 2.0 with peak transfer rate of up to 480Mbps.

The AGP4X integrated graphics supports interface such as TV out, LVDS and CRT. It can have up to DVMT 64MB shared memory. One-channel and dual-channel digital display are supported with resolutions of up to 1600x1200 and 2048x1536 @ 60Hz respectively.

The MB800 motherboard supports Pentium 4 processors of up to 2.6GHz+ and comes optionally with a secondary LAN that supports either up to 1000Mb/s (Gigabit LAN) or 100Mb/s data transfer rate. Two DDR slots on board support up to 2GB of DDR200/266 non-ECC DDR SDRAM modules. Hardware monitoring is available with the Winbond W83627HF chipset on board.

Other special features of the board includes 256-level watchdog timer, DiskOnChip socket, digital I/O (4 in / 4 out) and PCI to ISA bridge. Measuring 305mm by 244mm, MB800 also has an AGP slot, three PCI slots, three ISA slots and a MicroPCI socket. With ISA slots on board and a long life cycle, MB800 is the powerful platform of choice for industrial applications.

Checklist

Your MB800 package should include the items listed below.

- The MB800 Industrial motherboard
- This User's Manual
- 1 IDE Ribbon Cable
- 1 Floppy Ribbon Cable
- 1 Bracket for 1 Serial Port
- 1 Bracket for 2 Serial Ports
- I/O Shield Plate
- 1 CD containing the following:
 - Chipset Drivers
 - Flash Memory Utility

Specifications

CPU Socket	Socket 478
CPU	Intel Pentium 4, 1.70GHz ~ 2.60GHz+
CPU PSB (Processor Side Bus)	400MHz (100MHz x4), / 533MHz (133MHz x4)
Chipset	Intel 845G / GE Chipset
L2 Cache	128K/256K/512K, CPU integrated
BIOS	Award BIOS, ACPI supported
System Memory	Two DDR slots Support up to 2GB DDR200/266 non-ECC DDR SDRAM DDR333 supported by 845GE chipset (MB800H / MB800FH)
Hyper Threading	Supported by 845GE chipset (MB800H / MB800FH)
Onboard VGA	Intel 845G / GE chipset integrated, AGP 4X Supports CRT VGA interface Optionally supports TMDS, LVDS, TV-out interface Supports DVMT 64MB shared memory Supports Dual channel DVO port CRT Monitor: up to 2048x1536 @60Hz Supports one-channel digital display, 1600x1200 @60Hz Supports dual-channel digital display, 2048x1536 @60Hz
Primary LAN	ICH4 integrated Ethernet, 10/ 100Base-TX
Secondary LAN (option)	Intel 82540EM (Gigabit LAN) / 82551QM (10/100Mb)
Audio	ICH4 integrated audio with AC97 Codec Audio connectors on board
LPC I/O	Winbond 83627HF supports IrDA x 1, Parallel x 1, COM1 (RS232), COM2 (RS232/422/485), FDC up to 2.88MB (3 Mode support) Hardware Monitor
IDE Interface	Built in ICH4; Two enhanced IDE supports 4 IDE devices including UDMA33/66/100, PIO mode 4 and bus master
FDD Interface	Supports up to two floppy disk drives: 3.5" and/or 5.25" drives: 3 Mode support
Parallel Port	One parallel port supports SPP/EPP/ECP
Serial Ports	One RS-232/422/485 and three RS-232 ports COM3 and COM4 supported by Winbond 83877
Watchdog Timer	Generates system reset; 256 levels
SSD Interface	Supports 2MB~288MB M-Systems DiskOnChip flash disk
H/W Monitoring	Built in Winbond W83627HF; monitors system/CPU temperature and voltage status
USB	USB 1.1 and 2.0 compliant Supports 4 USB ports
IrDA	Pin header
Keyboard / Mouse	PS/2 type keyboard and mouse connectors
Digital I/O	4 in / 4 out
Expansion Slots	1 AGP, 3 PCI, 3 ISA, 1 MicroPCI
PCI to ISA Bridge	Winbond 83628, Winbond 83629
Power Connector	ATX 12V power connector (J10, J12 connectors)
Form Factor	ATX Motherboard
Dimensions	305mm x 244mm (12" x 9.6")

Board Dimensions

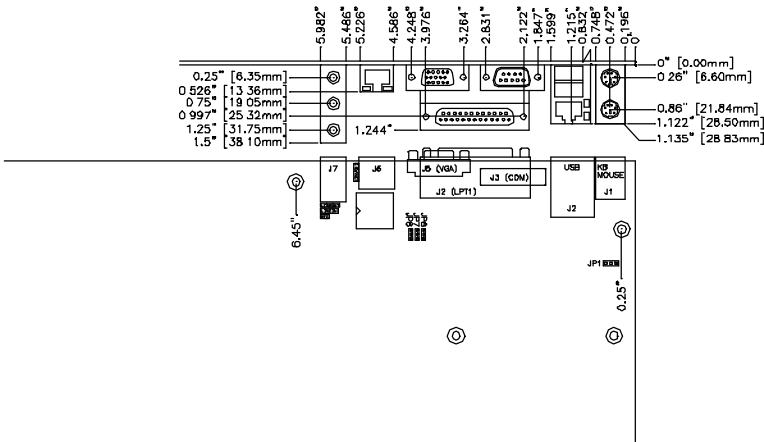
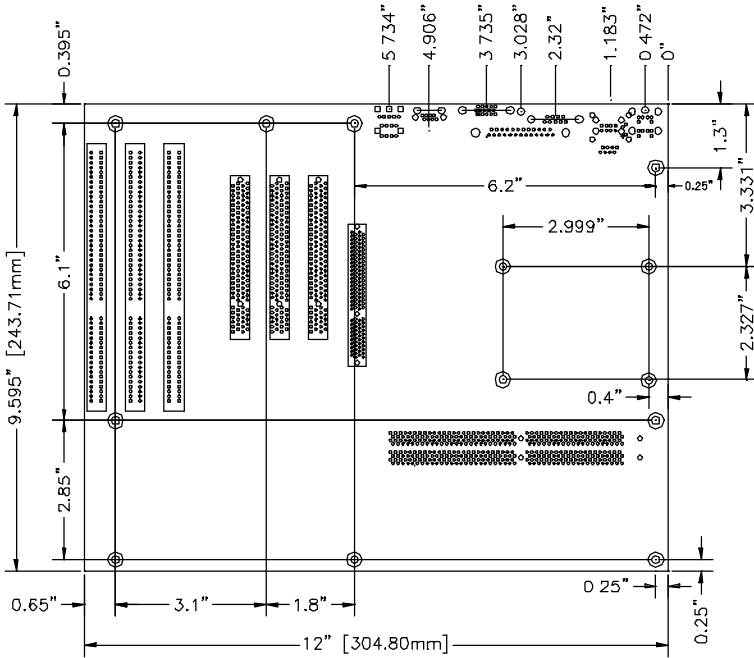

Installations

This section provides information on how to use the jumpers and connectors on the MB800 in order to set up a workable system. The topics covered are:

Installing the CPU.....	6
ATX Power Installation	7
MicroPCI Daughter Card Installation	7
Installing the Memory	8
Setting the Jumpers.....	9
Connectors on MB800	13

Installing the CPU

The MB800 motherboard supports a Socket 478 processor socket for Intel Pentium 4 processors.

The Socket 478 processor socket comes with a lever to secure the processor. Raise this lever to about a 90° angle to allow the insertion of the processor. Place the processor into the socket by making sure the notch on the corner of the CPU corresponds with the notch on the inside of the socket. Once the processor has slide into the socket, return the lever to the lock position. Refer to the figures below.

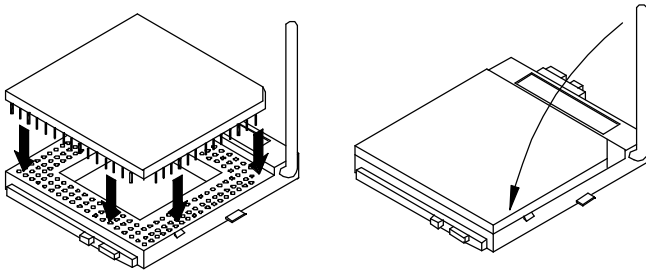

After you have installed the processor into the socket, check if the jumpers for the CPU type and speed are correct.

NOTE: *Ensure that the CPU heat sink and the CPU top surface are in total contact to avoid CPU overheating problem that would cause your system to hang or be unstable.*

ATX Power Installation

Power is provided to the MB800 motherboard with the J10 standard ATX power supply connector and J12 ATX 12V power connector. These two power connectors should be utilized for the motherboard to function.

MicroPCI Daughter Card Installation

To insert the MicroPCI daughter cards, position it at 30° to the PCB and gently push it into the MicroPCI connector (See Figure 1 below). The card will not fit when inserted at an angle of 45° or 15°. Once inserted, slowly press the card towards the PCB until it locks on both sides to the clips of the connector. Screw the card to the PCB to secure the installation. To remove the MicroPCI card, pull the 'clips' sideways as shown in Figure 2 below.

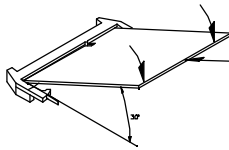

Figure 1.

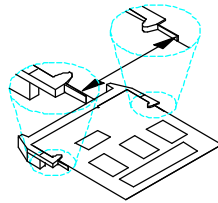

Figure 2.

Installing the Memory

The MB800 motherboard supports two DDR memory sockets for a maximum total memory of 2GB in DDR memory type. The memory module capacities supported are 64MB, 128MB, 256MB, 512MB and 1GB. The following table lists the supported DDR DIMM configurations. Intel 845G supports configurations defined in the JEDEC DDR DIMM specification only (A,B,C). Non-JEDEC standard DIMMs such as double-sided x16 DDR SDRAM DIMMs are not supported.

Supported DDR DIMM Configurations.

Density	64 Mbit		128Mbit		256Mbit		512Mbit	
Device Width	X8	X16	X8	X16	X8	X16	X8	X16
Single/Double	SS/DS	SS/DS	SS/DS	SS/DS	SS/DS	SS/DS	SS/DS	SS/DS
184-pin DDR	64/128MB	32MB/NA	128/256M B	64MB/NA	256/512M B	128MB/NA	512/1024 M	256MB/NA

Installing and Removing Memory Modules

To install the DDR modules, locate the memory slot on the motherboard and perform the following steps:

1. Hold the DDR module so that the key of the DDR module align with those on the memory slot.
2. Gently push the DDR module in an upright position until the clips of the slot close to hold the DDR module in place when the DDR module touches the bottom of the slot.
3. To remove the DDR module, press the clips with both hands.

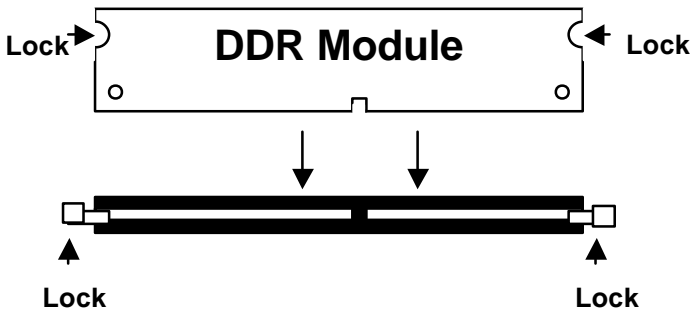

Setting the Jumpers

Jumpers are used on MB800 to select various settings and features according to your needs and applications. Contact your supplier if you have doubts about the best configuration for your needs. The following lists the connectors on MB800 and their respective functions.

Jumper Locations on MB800	10
Configuring the CPU Frequency	11
JP3, JP4, JP5: RS232/422/485 (COM2) Selection	11
JP6, JP7, JP8, JP9, JP10: CRT VGA Signal Select.....	11
JP12: DiskOnChip Address Select.....	11
JP14: Gigabit LAN Enable/Disable.....	12
JP15: COM4 RI/Voltage Selection.....	12
JP17: Clear CMOS Contents	12

Jumper Locations on MB800

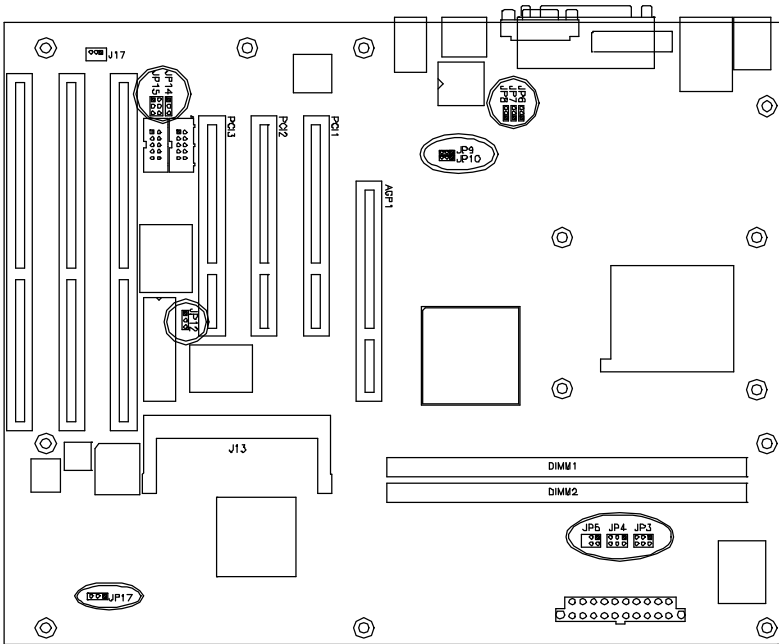

Jumper.....	Page No.
JP3, JP4, JP5: RS232/422/485 (COM2) Selection	11
JP6, JP7, JP8, JP9, JP10: CRT VGA Signal Select.....	11
JP12: DiskOnChip Address Select.....	11
JP14: Gigabit LAN Enable/Disable.....	12
JP15: COM4 RI/Voltage Selection.....	12
JP17: Clear CMOS Contents	12

Configuring the CPU Frequency

The MB800 motherboard does not provide DIP switches to configure the processor speed (CPU frequency). The CPU frequency and processor side bus of the processor can be automatically detected by the motherboard.

JP3, JP4, JP5: RS232/422/485 (COM2) Selection

COM1 is fixed for RS-232 use only.

COM2 is selectable for RS232, RS-422 and RS-485.

The following table describes the jumper settings for COM2 selection.

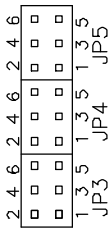



COM2 Function	RS-232	RS-422	RS-485
Jumper Setting (pin closed)	JP3: 1-2	JP3: 3-4	JP3: 5-6
	JP4: 3-5 & 4-6	JP4: 1-3 & 2-4	JP4: 1-3 & 2-4
	JP5: 3-5 & 4-6	JP5: 1-3 & 2-4	JP5: 1-3 & 2-4

JP6, JP7, JP8, JP9, JP10: CRT VGA Signal Select

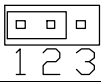
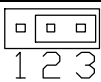
Use JP6, JP7, JP8, JP9, and JP10 to select the CRT VGA signal, either from the on board VGA or from an optional MicroPCI VGA.



JP6/7/8/9/10	Function
	On Board VGA
	MicroPCI VGA

JP12: DiskOnChip Address Select

JP12	Address
	D0000-D7FFF
	D8000-DFFFF (default)

JP14: Gigabit LAN Enable/Disable

If your motherboard comes with the Gigabit LAN functionality, you can use this jumper to enable or disable it.

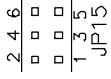
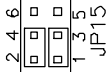
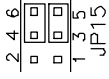

JP14	Setting	Function
	Pin 1-2 Short/Closed	Enable
	Pin 2-3 Short/Closed	Disable

JP15: COM4 RI/Voltage Selection

COM4 Function	RI	5V	12V
Jumper Setting			

JP17: Clear CMOS Contents

Use JP17, a 3-pin header, to clear the CMOS contents. *Note that the ATX-power connector should be disconnected from the motherboard before clearing CMOS.*

JP17	Setting	Function
	Pin 1-2 Short/Closed	Normal
	Pin 2-3 Short/Closed	Clear CMOS

Connectors on MB800

The connectors on MB800 allows you to connect external devices such as keyboard, floppy disk drives, hard disk drives, printers, etc. The following table lists the connectors on MB800 and their respective functions.

Connector Locations on MB800	14
IDE1, IDE2: EIDE Connectors.....	15
FDD1: Floppy Drive Connector	16
FAN1: CPU Fan Power Connector	16
FAN2: System Fan Power Connector	16
FAN3: Chassis Fan Power Connector.....	17
J1: PS/2 Keyboard and PS/2 Mouse Connectors	17
J2: USB and LAN1 RJ45 Connectors	17
J3, J11, J15, J16: Serial Ports.....	18
J4: Parallel Port Connector.....	19
J5: VGA CRT Connector	19
J6: Gigabit LAN RJ45 Connector	19
J7: Line Out, Line In, Mic Connector.....	20
J8: IrDA Connector	20
J10: ATX Power Supply Connector	20
J12: ATX 12V Power Connector	20
J13: MicroPCI Socket Connector.....	21
J14: CD-In Audio Connector.....	21
J17: Wake on LAN Connector.....	21
J18: Digital I/O Connector (4 in, 4 out).....	21
J19: USB Connector.....	22
J20: System Function Connector.....	22

Connector Locations on MB800

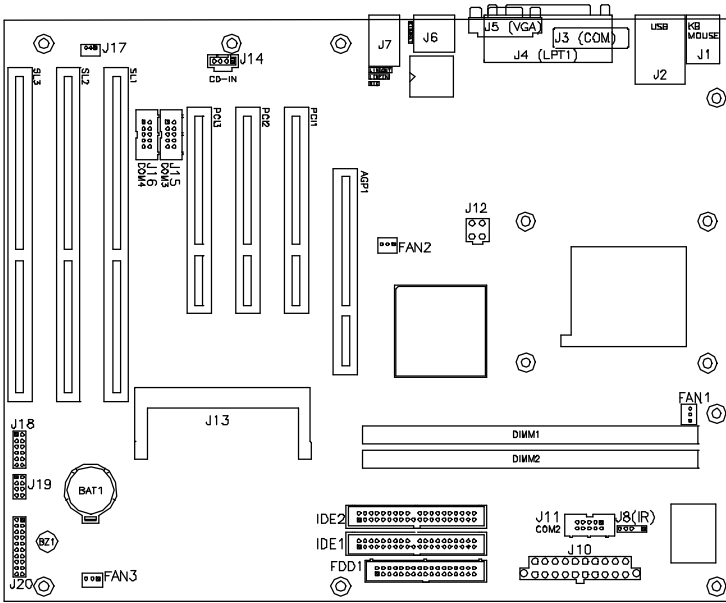

- IDE1, IDE2: EIDE Connectors
- FDD1: Floppy Drive Connector
- FAN1: CPU Fan Power Connector
- FAN2: System Fan Power Connector
- FAN3: Chassis Fan Power Connector
- J1: PS/2 Keyboard and PS/2 Mouse Connectors
- J2: USB and LAN1 RJ45 Connectors
- J3, J11, J15, J16: Serial Ports
- J4: Parallel Port Connector
- J5: VGA CRT Connector
- J6: Gigabit LAN RJ45 Connector
- J7: Line Out, Line In, Mic Connector
- J8: IrDA Connector
- J10: ATX Power Supply Connector
- J12: ATX 12V Power Connector
- J13: MicroPCI Socket Connector
- J14: CD-In Audio Connector
- J17: Wake on LAN Connector
- J18: Digital I/O Connector (4 in, 4 out)
- J19: USB Connector
- J20: System Function Connector

IDE1, IDE2: EIDE Connectors

IDE1: Primary IDE Connector

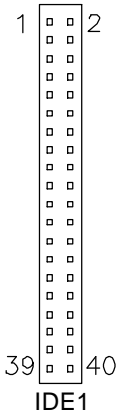

Signal Name	Pin #	Pin #	Signal Name
Reset IDE	1	2	Ground
Host data 7	3	4	Host data 8
Host data 6	5	6	Host data 9
Host data 5	7	8	Host data 10
Host data 4	9	10	Host data 11
Host data 3	11	12	Host data 12
Host data 2	13	14	Host data 13
Host data 1	15	16	Host data 14
Host data 0	17	18	Host data 15
Ground	19	20	Protect pin
DRQ0	21	22	Ground
Host IOW	23	24	Ground
Host IOR	25	26	Ground
IOCHRDY	27	28	Host ALE
DACK0	29	30	Ground
IRQ14	31	32	No connect
Address 1	33	34	No connect
Address 0	35	36	Address 2
Chip select 0	37	38	Chip select 1
Activity	39	40	Ground

IDE2: Secondary IDE Connector

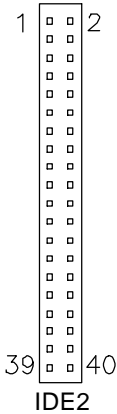

Signal Name	Pin #	Pin #	Signal Name
Reset IDE	1	2	Ground
Host data 7	3	4	Host data 8
Host data 6	5	6	Host data 9
Host data 5	7	8	Host data 10
Host data 4	9	10	Host data 11
Host data 3	11	12	Host data 12
Host data 2	13	14	Host data 13
Host data 1	15	16	Host data 14
Host data 0	17	18	Host data 15
Ground	19	20	Protect pin
DRQ1	21	22	Ground
Host IOW	23	24	Ground
Host IOR	25	26	Ground
IOCHRDY	27	28	Host ALE
DACK1	29	30	Ground
IRQ15	31	32	No connect
Address 1	33	34	No connect
Address 0	35	36	Address 2

Chip select 0	37	38	Chip select 1
Activity	39	40	Ground

FDD1: Floppy Drive Connector

FDD1 is a 34-pin header and will support up to 2.88MB floppy drives.

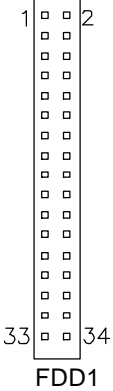

Signal Name	Pin #	Pin #	Signal Name
Ground	1	2	RM/LC
Ground	3	4	No connect
Ground	5	6	No connect
Ground	7	8	Index
Ground	9	10	Motor enable 0
Ground	11	12	Drive select 1
Ground	13	14	Drive select 0
Ground	15	16	Motor enable 1
Ground	17	18	Direction
Ground	19	20	Step
Ground	21	22	Write data
Ground	23	24	Write gate
Ground	25	26	Track 00
Ground	27	28	Write protect
Ground	29	30	Read data
Ground	31	32	Side 1 select
Ground	33	34	Diskette change

FAN1: CPU Fan Power Connector

FAN1 is a 3-pin header for the CPU fan. The fan must be a 12V fan.

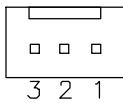

Pin #	Signal Name
1	Ground
2	+12V
3	Rotation detection

FAN2: System Fan Power Connector

FAN2 is a 3-pin header for the system fan. The fan must be a 12V fan.

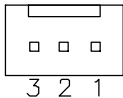

Pin #	Signal Name
1	Ground
2	+12V
3	Rotation detection

FAN3: Chassis Fan Power Connector

FAN3 is a 3-pin header for a 12V fan.

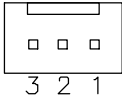

Pin #	Signal Name
1	Ground
2	+12V
3	Rotation detection

J1: PS/2 Keyboard and PS/2 Mouse Connectors

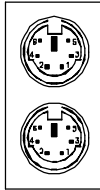

PS/2 Mouse

PS/2 Keyboard

Below are the pin-out assignments of the connectors.

Signal Name	Keyboard	Mouse	Signal Name
Keyboard data	1	1	Mouse data
N.C.	2	2	N.C.
GND	3	3	GND
5V	4	4	5V
Keyboard clock	5	5	Mouse clock
N.C.	6	6	N.C.

J2: USB and LAN1 RJ45 Connectors

J2 consists of an RJ-45 connector (top) and two stacked USB ports. Refer to the section below for their respective pin assignments.

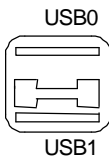
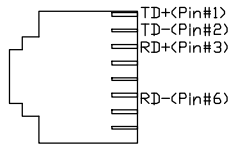

Pin #	Signal Name
1	Vcc
2	USB-
3	USB+
4	Ground

J3, J11, J15, J16: Serial Ports

J3 (COM1) is a DB-9 connector, while J11 (COM2), J15 (COM3) and J16 (COM4). Refer to the table below for their pin assignments.

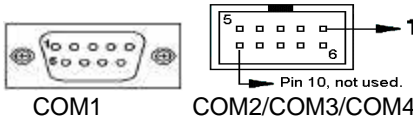

Signal Name	Pin #	Pin #	Signal Name
DCD, Data carrier detect	1	6	DSR, Data set ready
RXD, Receive data	2	7	RTS, Request to send
TXD, Transmit data	3	8	CTS, Clear to send
DTR, Data terminal ready	4	9	RI, Ring indicator
GND, ground	5	10	Not Used

J11 (COM2) is jumper selectable for RS-232, RS-422 and RS-485.

Pin #	Signal Name		
	RS-232	R2-422	RS-485
1	DCD	TX-	DATA-
2	RX	TX+	DATA+
3	TX	RX+	NC
4	DTR	RX-	NC
5	Ground	Ground	Ground
6	DSR	RTS-	NC
7	RTS	RTS+	NC
8	CTS	CTS+	NC
9	RI	CTS-	NC
10	NC	NC	NC

J4: Parallel Port Connector

The following table describes the pin out assignments of this connector.

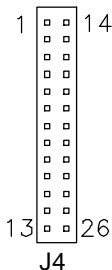

Signal Name	Pin #	Pin #	Signal Name
Line printer strobe	1	14	AutoFeed
PD0, parallel data 0	2	15	Error
PD1, parallel data 1	3	16	Initialize
PD2, parallel data 2	4	17	Select
PD3, parallel data 3	5	18	Ground
PD4, parallel data 4	6	19	Ground
PD5, parallel data 5	7	20	Ground
PD6, parallel data 6	8	21	Ground
PD7, parallel data 7	9	22	Ground
ACK, acknowledge	10	23	Ground
Busy	11	24	Ground
Paper empty	12	25	Ground
Select	13	N/A	N/A

J5: VGA CRT Connector

The pin assignments of the J5 VGA CRT connector are as follows:

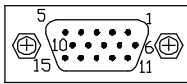

J5

Signal Name	Pin	Pin	Signal Name
Red	1	2	Green
Blue	3	4	N.C.
GND	5	6	GND
GND	7	8	GND
N.C.	9	10	GND
N.C.	11	12	N.C.
HSYNC	13	14	VSYNC
NC	15		

J6: Gigabit LAN RJ45 Connector

J6 is the Gigabit LAN RJ45 connector.

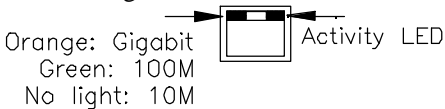

J7: Line Out, Line In, Mic Connector

The figure below shows the location of Line Out, Line In and Mic connectors on J7.

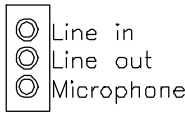

J8: IrDA Connector

J8 is used for an optional IrDA connector for wireless communication.

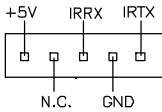

Pin #	Signal Name
1	+5V
2	No connect
3	Ir RX
4	Ground
5	Ir TX

J10: ATX Power Supply Connector

J10 is a 20-pin ATX power supply connector. Refer to the following table for the pin out assignments.

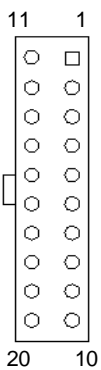

Signal Name	Pin #	Pin #	Signal Name
3.3V	11	1	3.3V
-12V	12	2	3.3V
Ground	13	3	Ground
PS-ON	14	4	+5V
Ground	15	5	Ground
Ground	16	6	+5V
Ground	17	7	Ground
-5V	18	8	Power good
+5V	19	9	5VSB
+5V	20	10	+12V

J12: ATX 12V Power Connector

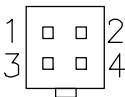

Pin #	Signal Name
1	Ground
2	Ground
3	+12V
4	+12V

J13: MicroPCI Socket Connector

The MicroPCI socket connector supports MicroPCI card with various functions such as VGA, LAN, IEEE1394, SCSI and combo functions.

J14: CD-In Audio Connector

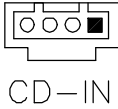

Pin #	Signal Name
1	CD Audio L
2	Ground
3	Ground
4	CD Audio R

J17: Wake on LAN Connector

J17 is a 3-pin header for the Wake on LAN function that will function properly only with an ATX power supply with 5VSB that has 1A.

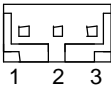

Pin #	Signal Name
1	+5VSB
2	Ground
3	Wake on LAN

J18: Digital I/O Connector (4 in, 4 out)

This 12-pin Digital I/O connector supports TTL levels and is used to control external devices requiring ON/OFF circuitry.

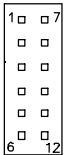

Signal Name	Pin #	Pin #	Signal Name
IN0	1	7	+5V
IN1	2	8	OUT0
IN2	3	9	Ground
IN3	4	10	OUT1
GROUND	5	11	+12V
OUT2	6	12	OUT3

J19: USB Connector

J19 connector will support the 3rd and 4th USB ports.

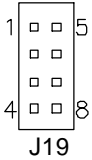

Signal Name	Pin	Pin	Signal Name
Vcc	1	5	Ground
USB2-	2	6	USB3+
USB2+	3	7	USB3-
Ground	4	8	Vcc

J20: System Function Connector

J20 provides connectors for system indicators that provide light indication of the computer activities and switches to change the computer status. J20 is a 20-pin header that provides interfaces for the following functions.

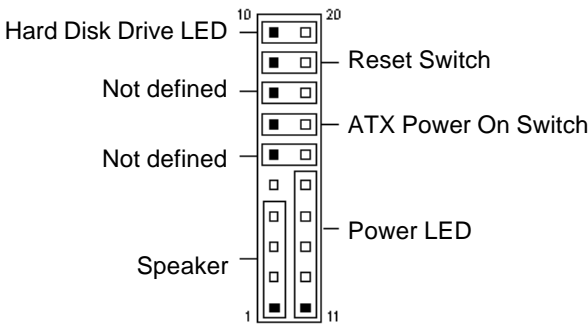

Speaker: Pins 1 - 4

This connector provides an interface to a speaker for audio tone generation. An 8-ohm speaker is recommended.



Pin #	Signal Name
1	Speaker out
2	No connect
3	Ground
4	+5V

Power LED: Pins 11 - 15

The power LED indicates the status of the main power switch.



Pin #	Signal Name
11	Power LED
12	No connect
13	Ground
14	No connect
15	Ground

ATX Power ON Switch: Pins 7 and 17

This 2-pin connector is an “ATX Power Supply On/Off Switch” on the system that connects to the power switch on the case. When pressed, the power switch will force the system to power on. When pressed again, it will force the system to power off.

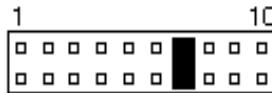

Reset Switch: Pins 9 and 19

The reset switch allows the user to reset the system without turning the main power switch off and then on again. Orientation is not required when making a connection to this header.

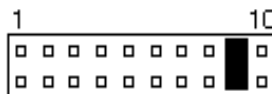

Hard Disk Drive LED Connector: Pins 10 and 20

This connector connects to the hard drive activity LED on control panel. This LED will flash when the HDD is being accessed.

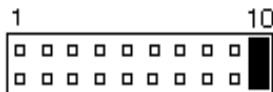

Pin #	Signal Name
10	HDD Active
20	5V

Watchdog Timer Configuration

The WDT is used to generate a variety of output signals after a user programmable count. The WDT is suitable for use in the prevention of system lock-up, such as when software becomes trapped in a deadlock. Under these sort of circumstances, the timer will count to zero and the selected outputs will be driven. Under normal circumstance, the user will restart the WDT at regular intervals before the timer counts to zero.

SAMPLE CODE:

This code and information is provided "as is" without warranty of any kind, either expressed or implied, including but not limited to the implied warranties of merchantability and/or fitness for a particular purpose.

```

;[]=====
; Name : Enable_And_Set_Watchdog
; IN   : AL - 1 sec ~ 255sec
; OUT  : None
;[]=====
Enable_And_Set_Watchdog Proc Near
    push    ax                ;save time interval
    call   Unlock_Chip

    mov     cl, 2Bh
    call   Read_Reg
    and    al, NOT 10h
    call   Write_Reg         ;set GP24 as WDTO

    mov     cl, 07h
    mov     al, 08h
    call   Write_Reg         ;switch to LD8

    mov     cl, 0F5h
    call   Read_Reg
    and    al, NOT 08h
    call   Write_Reg         ;set count mode as second

```

```

    pop ax
    mov  cl, 0F6h
    call Write_Reg      ;set watchdog timer

    mov  al, 01h
    mov  cl, 30h
    call Write_Reg      ;watchdog enabled

    call Lock_Chip
    ret
Enable_And_Set_Watchdog Endp
;[]=====
; Name : Disable_Watchdog
; IN   : None
; OUT  : None
;[]=====
Disable_Watchdog Proc Near
    call Unlock_Chip

    mov  cl, 07h
    mov  al, 08h
    call Write_Reg      ;switch to LD8

    xor  al, al
    mov  cl, 0F6h
    call Write_Reg      ;clear watchdog timer

    xor  al, al
    mov  cl, 30h
    call Write_Reg      ;watchdog disabled

    call Lock_Chip
    ret
Disable_Watchdog Endp
;[]=====
; Name : Unlock_Chip
; IN   : None
; OUT  : None

```

```
;[]=====
Unlock_Chip Proc Near
    mov dx, 2Eh
    mov al, 87h
    out dx, al
    out dx, al
    ret
Unlock_Chip Endp
;[]=====
; Name : Lock_Chip
; IN : None
; OUT : None
;[]=====
Unlock_Chip Proc Near
    mov dx, 2Eh
    mov al, 0AAh
    out dx, al
    ret
Unlock_Chip Endp
;[]=====
; Name : Write_Reg
; IN : CL - register index
; AL - Value to write
; OUT : None
;[]=====
Write_Reg Proc Near
    push ax
    mov dx, 2Eh
    mov al, cl
    out dx, al
    pop ax
    inc dx
    out dx, al
    ret
Write_Reg Endp
;[]=====
; Name : Read_Reg
; IN : CL - register index
; OUT : AL - Value to read
```

```
;[]=====
Read_Reg Proc Near
    mov     al, cl
    mov     dx, 2Eh
    out    dx, al
    inc    dx
    in     al, dx
    ret
Read_Reg Endp
;[]=====
```

This page is intentionally left blank.

BIOS Setup

This chapter describes the different settings available in the Award BIOS that comes with the motherboard. The topics covered in this chapter are as follows:

BIOS Introduction	30
BIOS Setup.....	30
Standard CMOS Setup.....	32
Advanced BIOS Features.....	35
Advanced Chipset Features	38
Integrated Peripherals	40
Power Management Setup.....	43
PNP/PCI Configurations.....	46
PC Health Status.....	47
Frequency/Voltage Control.....	48
Load Fail-Safe Defaults	49
Load Setup Defaults	49
Set Supervisor/User Password.....	49
Save & Exit Setup.....	49
Exit Without Saving	49

BIOS Introduction

The Award BIOS (Basic Input/Output System) installed in your computer system's ROM supports Intel Pentium 4 processors. The BIOS provides critical low-level support for a standard device such as disk drives, serial ports and parallel ports. It also adds virus and password protection as well as special support for detailed fine-tuning of the chipset controlling the entire system.

BIOS Setup

The Award BIOS provides a Setup utility program for specifying the system configurations and settings. The BIOS ROM of the system stores the Setup utility. When you turn on the computer, the Award BIOS is immediately activated. Pressing the key immediately allows you to enter the Setup utility. If you are a little bit late pressing the key, POST (Power On Self Test) will continue with its test routines, thus preventing you from invoking the Setup. If you still wish to enter Setup, restart the system by pressing the "Reset" button or simultaneously pressing the <Ctrl>, <Alt> and <Delete> keys. You can also restart by turning the system Off and back On again. The following message will appear on the screen:

```
Press <DEL> to Enter Setup
```

In general, you press the arrow keys to highlight items, <Enter> to select, the <PgUp> and <PgDn> keys to change entries, <F1> for help and <Esc> to quit.

When you enter the Setup utility, the Main Menu screen will appear on the screen. The Main Menu allows you to select from various setup functions and exit choices.

CMOS Setup Utility – Copyright ©1984-2001 Award Software

Standard CMOS Features	Frequency/Voltage Control
Advanced BIOS Features	Load Fail-Safe Defaults
Advanced Chipset Features	Load Optimized Defaults
Integrated Peripherals	Set Supervisor Password
Power Management Setup	Set User Password
PnP/PCI Configurations	Save & Exit Setup
PC Health Status	Exit Without Saving
ESC : Quit	↑ ↓ → ← : Select Item
F10 : Save & Exit Setup	
Time, Date, Hard Disk Type...	

The section below the setup items of the Main Menu displays the control keys for this menu. At the bottom of the Main Menu just below the control keys section, there is another section, which displays information on the currently highlighted item in the list.

Note: *If the system cannot boot after making and saving system changes with Setup, the Award BIOS supports an override to the CMOS settings that resets your system to its default.*

Warning: *It is strongly recommended that you avoid making any changes to the chipset defaults. These defaults have been carefully chosen by both Award and your system manufacturer to provide the absolute maximum performance and reliability. Changing the defaults could cause the system to become unstable and crash in some cases.*

Standard CMOS Setup

“Standard CMOS Setup” choice allows you to record some basic hardware configurations in your computer system and set the system clock and error handling. If the motherboard is already installed in a working system, you will not need to select this option. You will need to run the Standard CMOS option, however, if you change your system hardware configurations, the onboard battery fails, or the configuration stored in the CMOS memory was lost or damaged.

CMOS Setup Utility – Copyright ©1984-2001 Award Software
Standard CMOS Features

Date (mm:dd:yy)	Tue, Mar 26 2001	Item Help
Time (hh:mm:ss)	00 : 00 : 00	Menu Level
IDE Primary Master	Press Enter 13020 MB	Change the day, month, Year and century
IDE Primary Slave	Press Enter None	
IDE Secondary Master	Press Enter None	
IDE Secondary Slave	Press Enter None	
Drive A	1.44M, 3.5 in.	
Drive B	None	
Video	EGA/VGA	
Halt On	All Errors	
Base Memory	640K	
Extended Memory	129024K	
Total Memory	130048K	

At the bottom of the menu are the control keys for use on this menu. If you need any help in each item field, you can press the <F1> key. It will display the relevant information to help you. The memory display at the lower right-hand side of the menu is read-only. It will adjust automatically according to the memory changed. The following describes each item of this menu.

Date

The date format is:

Day : Sun to Sat
Month : 1 to 12
Date : 1 to 31
Year : 1994 to 2079

To set the date, highlight the “Date” field and use the PageUp/ PageDown or +/- keys to set the current time.

Time

The time format is: **Hour** : 00 to 23
Minute : 00 to 59
Second : 00 to 59

To set the time, highlight the “Time” field and use the <PgUp>/<PgDn> or +/- keys to set the current time.

IDE Primary HDDs / IDE Secondary HDDs

The onboard PCI IDE connectors provide Primary and Secondary channels for connecting up to four IDE hard disks or other IDE devices. Each channel can support up to two hard disks; the first is the “Master” and the second is the “Slave”.

Press <Enter> to configure the hard disk. The selections include Auto, Manual, and None. Select ‘Manual’ to define the drive information manually. You will be asked to enter the following items.

CYLS : Number of cylinders
HEAD : Number of read/write heads
PRECOMP : Write precompensation
LANDZ : Landing zone
SECTOR : Number of sectors

The Access Mode selections are as follows:

Auto
Normal (HD < 528MB)
Large (for MS-DOS only)
LBA (HD > 528MB and supports
Logical Block Addressing)

Drive A / Drive B

These fields identify the types of floppy disk drive A or drive B that has been installed in the computer. The available specifications are:

360KB	1.2MB	720KB	1.44MB	2.88MB
5.25 in.	5.25 in.	3.5 in.	3.5 in.	3.5 in.

Video

This field selects the type of video display card installed in your system. You can choose the following video display cards:

EGA/VGA	For EGA, VGA, SEGA, SVGA or PGA monitor adapters. (default)
CGA 40	Power up in 40 column mode.
CGA 80	Power up in 80 column mode.
MONO	For Hercules or MDA adapters.

Halt On

This field determines whether or not the system will halt if an error is detected during power up.

No errors	The system boot will not be halted for any error that may be detected.
All errors	Whenever the BIOS detects a non-fatal error, the system will stop and you will be prompted.
All, But Keyboard	The system boot will not be halted for a keyboard error; it will stop for all other errors
All, But Diskette	The system boot will not be halted for a disk error; it will stop for all other errors.
All, But Disk/Key	The system boot will not be halted for a keyboard or disk error; it will stop for all others.

Advanced BIOS Features

This section allows you to configure and improve your system and allows you to set up some system features according to your preference.

CMOS Setup Utility – Copyright ©1984-2001 Award Software
Advanced BIOS Features

		ITEM HELP
Virus Warning	Disabled	Menu Level
CPU L1 and L2 Cache	Enabled	
Quick Power On Self Test	Enabled	
First Boot Device	Floppy	
Second Boot Device	HDD-0	
Third Boot Device	CDROM	
Boot Other Device	Enabled	
Swap Floppy Drive	Disabled	
Boot Up Floppy Seek	Disabled	
Boot Up Numlock Status	On	
Gate A20 Option	Fast	
Typematic Rate Setting	Disabled	
Typematic Rate (chars/Sec)	6	
Typematic Delay (Msec)	250	
Security Option	Setup	
APIC Mode	Enabled	
MPS Version Control for OS	1.4	
OS Select For DRAM>64MB	Non-OS2	
Report No FDD For WIN 95	Yes	
Small Logo (EPA) Show	Enabled	
		Allows you choose the VIRUS warning feature for IDE Hard Disk boot sector protection. If this function is enabled and someone attempt to write data into this area, BIOS will show a warning message on screen and alarm beep

Virus Warning

This item protects the boot sector and partition table of your hard disk against accidental modifications. If an attempt is made, the BIOS will halt the system and display a warning message. If this occurs, you can either allow the operation to continue or run an anti-virus program to locate and remove the problem.

CPU L1 and L2 Cache

Cache memory is additional memory that is much faster than conventional DRAM (system memory). CPUs from 486-type on up contain internal cache memory, and most, but not all, modern PCs have additional (external) cache memory. When the CPU requests data, the system transfers the requested data from the main DRAM into cache memory, for even faster access by the CPU. These items allow you to enable (speed up memory access) or disable the cache function. By default, these items are *Enabled*.

Quick Power On Self Test

When enabled, this field speeds up the Power On Self Test (POST) after the system is turned on. If it is set to *Enabled*, BIOS will skip some items.

First/Second/Third Boot Device

These fields determine the drive that the system searches first for an operating system. The options available include *Floppy*, *LS/ZIP*, *HDD-0*, *SCSI*, *CDROM*, *HDD-1*, *HDD-2*, *HDD-3*, *LAN* and *Disable*.

Boot Other Device

These fields allow the system to search for an operating system from other devices other than the ones selected in the First/Second/Third Boot Device.

Swap Floppy Drive

This item allows you to determine whether or not to enable Swap Floppy Drive. When enabled, the BIOS swaps floppy drive assignments so that Drive A becomes Drive B, and Drive B becomes Drive A. By default, this field is set to *Disabled*.

Boot Up Floppy Seek

This feature controls whether the BIOS checks for a floppy drive while booting up. If it cannot detect one (either due to improper configuration or its absence), it will flash an error message.

Boot Up NumLock Status

This allows you to activate the NumLock function after you power up the system.

Gate A20 Option

This field allows you to select how Gate A20 is worked. Gate A20 is a device used to address memory above 1 MB.

Typematic Rate Setting

When disabled, continually holding down a key on your keyboard will generate only one instance. When enabled, you can set the two typematic controls listed next. By default, this field is set to *Disabled*.

Typematic Rate (Chars/Sec)

When the typematic rate is enabled, the system registers repeated keystrokes speeds. Settings are from 6 to 30 characters per second.

Typematic Delay (Msec)

When the typematic rate is enabled, this item allows you to set the time interval for displaying the first and second characters. By default, this item is set to *250msec*.

Security Option

This field allows you to limit access to the System and Setup. The default value is *Setup*. When you select *System*, the system prompts for the User Password every time you boot up. When you select *Setup*, the system always boots up and prompts for the Supervisor Password only when the Setup utility is called up.

APIC Mode

APIC stands for Advanced Programmable Interrupt Controller. The default setting is *Enabled*.

MPS Version Control for OS

This option specifies the MPS (Multiprocessor Specification) version for your operating system. MPS version 1.4 added extended configuration tables to improve support for multiple PCI bus configurations and improve future expandability. The default setting is *1.4*.

OS Select for DRAM > 64MB

This option allows the system to access greater than 64MB of DRAM memory when used with OS/2 that depends on certain BIOS calls to access memory. The default setting is *Non-OS/2*.

Report No FDD For WIN 95

If you are using Windows 95/98 without a floppy disk drive, select Enabled to release IRQ6. This is required to pass Windows 95/98's SCT test. You should also disable the Onboard FDC Controller in the Integrated Peripherals screen when there's no floppy drive in the system. If you set this feature to Disabled, the BIOS will not report the missing floppy drive to Win95/98.

Small Logo (EPA) Show

The EPA logo appears at the right side of the monitor screen when the system is boot up. The default setting is *Enabled*.

Advanced Chipset Features

This Setup menu controls the configuration of the chipset.

CMOS Setup Utility – Copyright ©1984-2001 Award Software
Advanced Chipset Features

DRAM Timing Selectable	By SPD	ITEM HELP
CAS Latency Time	2.5	Menu Level
Active to Precharge Delay	7	
DRAM RAS# to CAS# Delay	3	
DRAM RAS# Precharge	3	
Turbo Mode	Disabled	
Memory Frequency For	Auto	
System BIOS Cacheable	Enabled	
Video BIOS Cacheable	Enabled	
Delayed Transaction	Enabled	
Delay Prior to Thermal	16 Min	
AGP Aperture Size (MB)	64	
ICH4 LAN	Enabled	
** On-Chip VGA Setting **		
On-Chip VGA	Enabled	
On-Chip Frame Buffer Size	8MB	
Boot Display	Auto	

DRAM Timing Selectable

This option refers to the method by which the DRAM timing is selected. The default is *By SPD*.

CAS Latency Time

You can select CAS latency time in HCLKs of 2/2 or 3/3. The system board designer should set the values in this field, depending on the DRAM installed. Do not change the values in this field unless you change specifications of the installed DRAM or the installed CPU. The choices are 2 and 3.

Active to Precharge Delay

The default setting for the Active to Precharge Delay is **6**.

DRAM RAS# to CAS# Delay

This option allows you to insert a delay between the RAS (Row Address Strobe) and CAS (Column Address Strobe) signals. This delay occurs when the SDRAM is written to, read from or refreshed. Reducing the delay improves the performance of the SDRAM.

DRAM RAS# Precharge

This option sets the number of cycles required for the RAS to accumulate its charge before the SDRAM refreshes. The default setting for the Active to Precharge Delay is **3**.

Memory Frequency For

This field sets the frequency of the DRAM memory installed. The default setting is *Auto*. The other settings are *DDR200* and *DDR266*.

System BIOS Cacheable

The setting of *Enabled* allows caching of the system BIOS ROM at F000h-FFFFh, resulting in better system performance. However, if any program writes to this memory area, a system error may result.

Video BIOS Cacheable

The Setting *Enabled* allows caching of the video BIOS ROM at C0000h-F7FFFh, resulting in better video performance. However, if any program writes to this memory area, a system error may result.

Delayed Transaction

The chipset has an embedded 32-bit posted write buffer to support delay transactions cycles. Select *Enabled* to support compliance with PCI specification version 2.1.

Delay Prior to Thermal

This field activates the CPU thermal function after the systems boots for the set number of minutes. The options are *16Min* and *64Min*.

AGP Aperture Size

The field sets aperture size of the graphics. The aperture is a portion of the PCI memory address range dedicated for graphics memory address space. Host cycles that hit the aperture range are forwarded to the AGP without any translation. The default setting is *64M*.

ICH4 LAN

By default, this field sets the ICH4 LAN function as *Enabled*.

On-Chip VGA

By default, the On-Chip VGA or chipset-integrated VGA is *Enabled*.

On-Chip Frame Buffer Size

The On-Chip Frame Buffer Size can be set us 1MB or 8MB. This memory is shared with the system memory.

Boot Display

Boot Display determines the display output device where the system boots. The options are Auto, CRT, TV and EFP.

Integrated Peripherals

This section sets configurations for your hard disk and other integrated peripherals.

CMOS Setup Utility – Copyright ©1984-2001 Award Software
Integrated Peripherals

			ITEM HELP
On-Chip Primary PCI IDE	Enabled		Menu Level
IDE Primary Master PIO	Auto		
IDE Primary Slave PIO	Auto		
IDE Primary Master UDMA	Auto		
IDE Primary Slave UDMA	Auto		
On-Chip Secondary PCI IDE	Enabled		
IDE Secondary Master PIO	Auto		
IDE Secondary Slave PIO	Auto		
IDE Secondary Master UDMA	Auto		
IDE Secondary Slave UDMA	Auto		
USB Controller	Enabled		
USB 2.0 Controller	Disabled		
USB Keyboard Support	Disabled		
AC97 Audio	Auto		
Init Display First	PCI Slot		
IDE HDD Block Mode	Enabled		
POWER ON Function	BUTTON Only		
Hot Key Power ON	Ctrl-F1		
Onboard FDC Controller	Enabled		
Onboard Serial Port 1	3F8/IRQ4		
Onboard Serial Port 2	2F8/IRQ3		
UART Mode Select	Normal		
Onboard Parallel Port	378/IRQ7		
Parallel Port Mode	SPP		
PWRON After PWR-Fail	Off		
Midi Port Address	330		
Onboard Serial Port 3	3E8H		
Serial Port 3 Use IRQ	IRQ5		
Onboard Serial Port 4	Disabled		
Serial Port 4 Use IRQ	IRQ10		
Digital I/O Address	Disabled		

OnChip Primary/Secondary PCI IDE

The integrated peripheral controller contains an IDE interface with support for two IDE channels. Select *Enabled* to activate each channel separately.

IDE Primary/Secondary Master/Slave PIO

These fields allow your system hard disk controller to work faster. Rather than have the BIOS issue a series of commands that transfer to or from the disk drive, PIO (Programmed Input/Output) allows the BIOS to communicate with the controller and CPU directly.

The system supports five modes, numbered from 0 (default) to 4, which primarily differ in timing. When Auto is selected, the BIOS will select the best available mode.

IDE Primary/Secondary Master/Slave UDMA

These fields allow your system to improve disk I/O throughput to 33Mb/sec with the Ultra DMA/33 feature. The options are *Auto* and *Disabled*.

USB Controller

The options for this field are *Enabled* and *Disabled*. By default, this field is set to *Enabled*.

USB 2.0 Controller

The options for this field are *Enabled* and *Disabled*. By default, this field is set to *Disabled*. In order to use USB 2.0, necessary OS drivers must be installed first.

USB Keyboard Support

The options for this field are *Enabled* and *Disabled*. By default, this field is set to *Disabled*.

AC97 Audio

The default setting of the AC97 Audio is *Auto*.

Init Display First

This field allows the system to initialize first the VGA card on chip or the display on the PCI Slot. By default, the *PCI Slot* VGA is initialized first.

IDE HDD Block Mode

This field allows your hard disk controller to use the fast block mode to transfer data to and from your hard disk drive.

Power On Function

This field sets how the system can be powered on from a system off state. The default setting is *Button Only*.

Hot Key Power ON

This field allows the system to be powered on by using hot keys. By default, the hot key is set as *Ctrl-F1*.

Onboard FDC Controller

Select *Enabled* if your system has a floppy disk controller (FDC) installed on the motherboard and you wish to use it. If you install an add-in FDC or the system has no floppy drive, select *Disabled* in this field. This option allows you to select the onboard FDD port.

Onboard Serial/Parallel Port

These fields allow you to select the onboard serial and parallel ports and their addresses. The default values for these ports are:

Serial Port 1	3F8H/IRQ4
Serial Port 2	2F8H/IRQ3
Serial Port 3	3E8H/IRQ5
Serial Port 4	Disabled
Parallel Port	378H/IRQ7

UART Mode Select

This field determines the UART 2 mode in your computer. The default value is *Normal*. Other options include *IrDA* and *ASKIR*.

Parallel Port Mode

This field allows you to determine parallel port mode function.

SPP	Standard Printer Port
EPP	Enhanced Parallel Port
ECP	Extended Capabilities Port

PWRON After PWR-Fail

This field sets the system power status whether on or off when power returns from a power failure situation.

Midi Port Address

The option settings for this field are *330*, *400* and *Disabled*. The default setting is *330*.

Midi Port IRQ

The default Midi Port IRQ is *10*.

Digital I/O Address

This field enables or disables the Digital I/O address.

Power Management Setup

The Power Management Setup allows you to save energy of your system effectively.

CMOS Setup Utility – Copyright ©1984-2001 Award Software
Power Management Setup

		ITEM HELP	
ACPI Function	Enabled	Menu Level	
ACPI Suspend Type	S1 (POS)		
Power Management	User Define		
Video Off Method	V/H Sync+Blank		
Video Off In Suspend	Yes		
Suspend Type	Stop Grant		
Modem Use IRQ	3		
Suspend Mode	Disabled		
HDD Power Down	Disabled		
Soft-Off by PWR-BTTN	Instant-Off		
CPU THRM-Throttling	50%		
Wake-Up by PCI Card	Disabled		
Power On by Ring	Disabled		
Resume by Alarm	Disabled		
Date (of Month) Alarm	0		
Time (hh:mm:ss) Alarm	0 : 0 : 0		
** Reload Global Timer Events **			
Primary IDE 0	Enabled		
Primary IDE 1	Enabled		
Secondary IDE 0	Enabled		
Secondary IDE 1	Enabled		
FDD, COM, LPT Port	Enabled		
PCI PIRQ[A-D] #	Enabled		

ACPI Function

Enable this function to support ACPI (Advance Configuration and Power Interface).

ACPI Suspend Type

This field sets the ACPI Power Management standby state. The default setting is *S1 (POS)*.

Power Management

This field allows you to select the type of power saving management modes. There are four selections for Power Management.

Min. Power Saving	Minimum power management
Max. Power Saving	Maximum power management.
User Define	Each of the ranges is from 1 min. to 1hr. Except for HDD Power Down which ranges from 1 min. to 15 min.

Video Off Method

This field defines the Video Off features. There are three options.

V/H SYNC + Blank	Default setting, blank the screen and turn off vertical and horizontal scanning.
DPMS	Allows BIOS to control the video display.
Blank Screen	Writes blanks to the video buffer.

Video Off In Suspend

When enabled, the video is off in suspend mode. The default is *Yes*.

Suspend Type

The default setting for the Suspend Type field is *Stop Grant*.

Modem Use IRQ

This field sets the IRQ used by the Modem. By default, the setting is **3**.

Suspend Mode

When enabled, and after the set time of system inactivity, all devices except the CPU will be shut off.

HDD Power Down

When enabled, and after the set time of system inactivity, the hard disk drive will be powered down while all other devices remain active.

Soft-Off by PWRBTN

This field defines the power-off mode when using an ATX power supply. The *Instant Off* mode allows powering off immediately upon pressing the power button. In the *Delay 4 Sec* mode, the system powers off when the power button is pressed for more than four seconds or enters the suspend mode when pressed for less than 4 seconds.

CPU THRM-Throttling

When the system enters Doze mode, the CPU clock runs only part of the time. You may select the percent of time that the clock runs.

Wake-Up by PCI Card

Enable this field to allow wake up function through a PCI card.

Power On by Ring

This field enables or disables the power on of the system through the modem connected to the serial port or LAN.

Resume by Alarm

This field enables or disables the resumption of the system operation. When enabled, the user is allowed to set the *Date* and *Time*.

Reload Global Timer Events

The HDD, FDD, COM, LPT Ports, and PCI PIRQ are I/O events which can prevent the system from entering a power saving mode or can awaken the system from such a mode. When an I/O device wants to gain the attention of the operating system, it signals this by causing an IRQ to occur. When the operating system is ready to respond to the request, it interrupts itself and performs the service.

PNP/PCI Configurations

This option configures the PCI bus system. All PCI bus systems on the system use INT#, thus all installed PCI cards must be set to this value.

CMOS Setup Utility – Copyright ©1984-2001 Award Software
PnP/PCI Configurations

PNP OS Install	No	ITEM HELP
Reset Configuration Data	Disabled	Menu Level
Resources Controlled By	Auto (ESCD)	Default is Disabled. Select Enabled to reset Extended System Configuration Data (ESCD) when you exit Setup if you have installed a new add-on and the system reconfiguration has caused such a serious conflict that the OS cannot boot
IRQ Resources	Press Enter	
DMA Resources	Press Enter	
PCI/VGA Palette Snoop	Disabled	

PNP OS Install

Enable the PNP OS Install option if it is supported by the operating system installed. The default value is *No*.

Reset Configuration Data

This field allows you to determine whether to reset the configuration data or not. The default value is *Disabled*.

Resources Controlled by

This PnP BIOS can configure all of the boot and compatible devices automatically with the use of a use a PnP operating system such as Windows 95.

PCI/VGA Palette Snoop

Some non-standard VGA display cards may not show colors properly. This field allows you to set whether or not MPEG ISA/VESA VGA cards can work with PCI/VGA. When this field is enabled, a PCI/VGA can work with an MPEG ISA/VESA VGA card. When this field is disabled, a PCI/VGA cannot work with an MPEG ISA/VESA card.

PC Health Status

This section shows the parameters in determining the PC Health Status. These parameters include temperatures, fan speeds and voltages.

CMOS Setup Utility – Copyright ©1984-2001 Award Software
PC Health Status

		ITEM HELP
CPU Warning Temperature	Disabled	
System Temp.	28°C/82°F	
CPU Temp	35°C/95°F	
Chassis Temp	39°C/102°F	
CPU FAN Speed (FAN1)	4166 RPM	
System FAN Speed (FAN2)	0 RPM	
Chassis FAN Speed (FAN3)	0 RPM	
Vcore (V)	1.63V	
VCC3(V)	3.37V	
+5(V)	5.05V	
+12(V)	12.09V	
-12(V)	(-)12.03V	
VBAT	3.21V	
5VSB(V)	5.05V	
Shutdown Temperature	Disabled	

CPU Warning Temperature

This field allows the user to set the temperature so that when the temperature is reached, the systems sounds a warning. This function can help prevent damage to the system that is caused by overheating.

Temperatures/Fan Speeds/Voltages

These fields are the parameters of the hardware monitoring function feature of the motherboard. The values are read-only values as monitored by the system and show the PC health status.

Shutdown Temperature

This field allows the user to set the temperature by which the system automatically shuts down once the threshold temperature is reached. This function can help prevent damage to the system that is caused by overheating.

Frequency/Voltage Control

This section shows the user how to configure the processor frequency.

CMOS Setup Utility – Copyright ©1984-2001 Award Software
 Frequency/Voltage Control

CPU Clock Ratio	12X	ITEM HELP
Auto Detect PCI Clk	Disabled	Menu Level
Spread Spectrum Modulated	Disabled	

CPU Clock Ratio

The CPU Ratio, also known as the CPU bus speed multiplier, can be configured through this field. The default setting is **12X**. This parameter can be used in conjunction with the above field to change the processor's speed.

Auto Detect PCI Clk

This field enables or disables the auto detection of the PCI clock.

Spread Spectrum

This field sets the value of the spread spectrum. The default setting is **Disabled**. This field is for CE testing use only.

Load Fail-Safe Defaults

This option allows you to load the troubleshooting default values permanently stored in the BIOS ROM. These default settings are non-optimal and disable all high-performance features.

Load Setup Defaults

This option allows you to load the default values to your system configuration. These default settings are optimal and enable all high performance features.

Set Supervisor/User Password

These two options set the system password. Supervisor Password sets a password that will be used to protect the system and Setup utility. User Password sets a password that will be used exclusively on the system. To specify a password, highlight the type you want and press <Enter>. The Enter Password: message prompts on the screen. Type the password, up to eight characters in length, and press <Enter>. The system confirms your password by asking you to type it again. After setting a password, the screen automatically returns to the main screen.

To disable a password, just press the <Enter> key when you are prompted to enter the password. A message will confirm the password to be disabled. Once the password is disabled, the system will boot and you can enter Setup freely.

Save & Exit Setup

This option allows you to determine whether or not to accept the modifications. If you type “Y”, you will quit the setup utility and save all changes into the CMOS memory. If you type “N”, you will return to Setup utility.

Exit Without Saving

Select this option to exit the Setup utility without saving the changes you have made in this session. Typing “Y” will quit the Setup utility without saving the modifications. Typing “N” will return you to Setup utility.

This page is intentionally left blank.

Drivers Installation

This section describes the installation procedures for software and drivers under the Windows 98, Windows NT 4.0 and Windows 2000. The software and drivers are included with the motherboard. If you find the items missing, please contact the vendor where you made the purchase. The contents of this section include the following:

Intel Chipset Software Installation Utility	52
Intel 845G Chipset Graphics Driver Installation	55
Intel Application Accelerator Installation	57
Sigmatel AC97 Codec Audio Driver Installation	61
Intel PRO LAN Drivers Installation.....	63

IMPORTANT NOTE:

After installing your Windows operating system (Windows 98/98SE/ME/2000/XP), you must install first the Intel Chipset Software Installation Utility before proceeding with the drivers installation.

Intel Chipset Software Installation Utility

The Intel Chipset Software Installation Utility, to be installed first before the software drivers, will enable Plug & Play INF support for Intel chipset components. Follow the instructions below to complete the installation under Windows 98/98SE/ME/2000/XP.

1. Insert the CD that comes with the motherboard and the screen below would appear. Click Intel Chipsets and then Intel 845G Chipset Drivers.

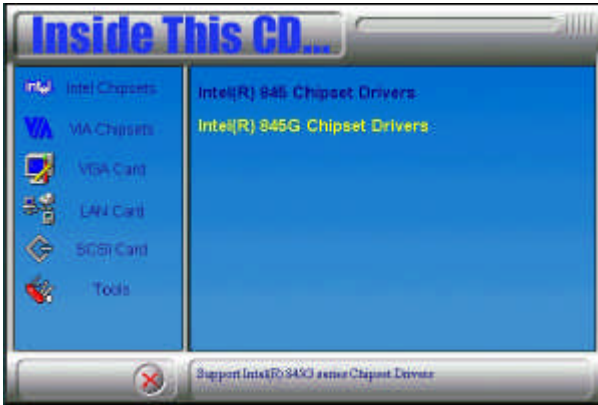

2. Click Intel Chipset Software Installation Utility.

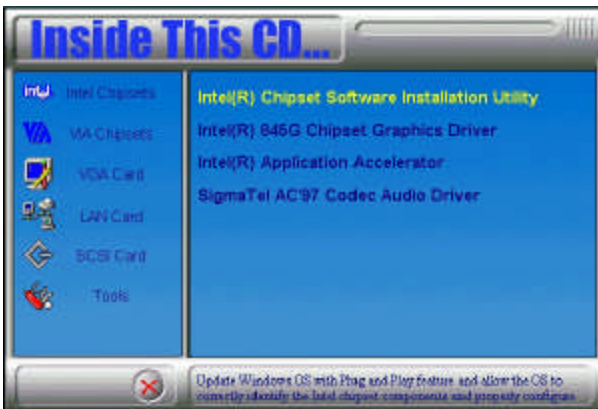

3. When the Welcome screen appears, click Next to continue.

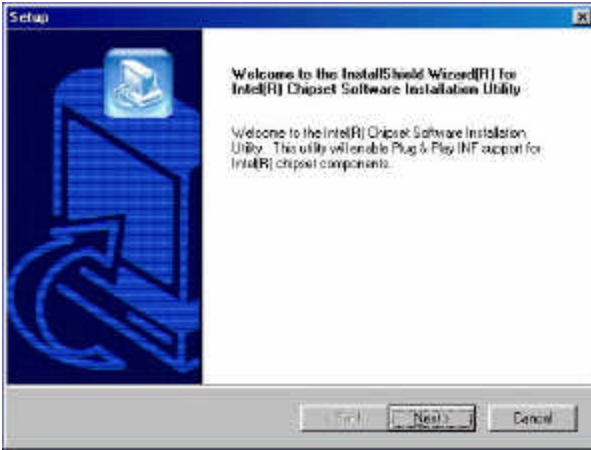

4. Click Yes to accept the software license agreement and proceed with the installation process.

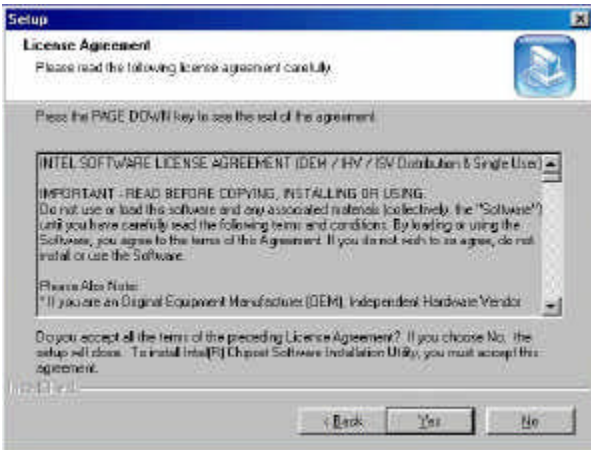

5. On Readme Information screen, click Next to continue the installation.

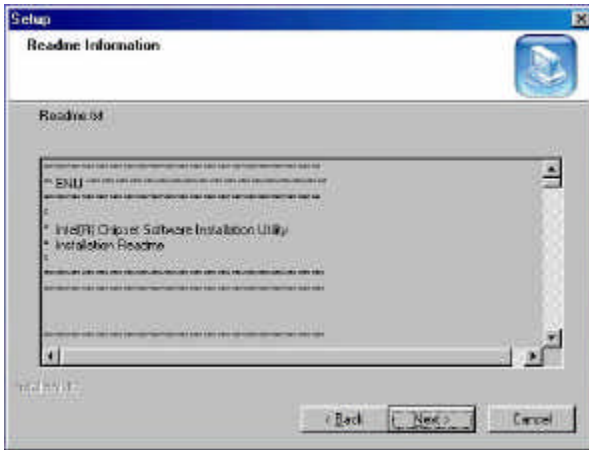

6. The Setup process is now complete. Click Finish to restart the computer and for changes to take effect. When the computer has restarted, the system will be able to find some devices. Restart your computer when prompted.

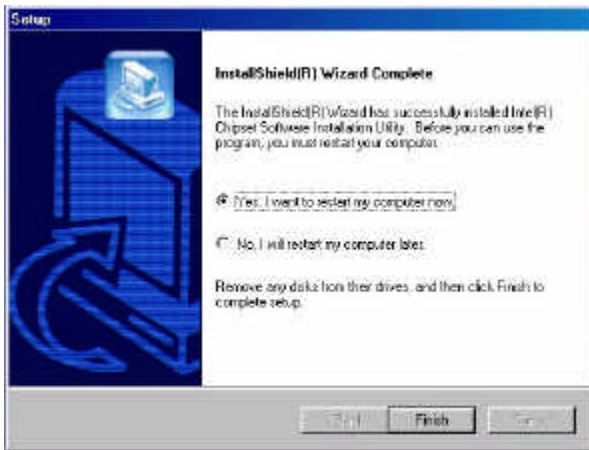

Intel 845G Chipset Graphics Driver Installation

Follow the steps below to install the Intel 845G graphics driver under Windows 98/98SE/ME/2000/XP/NT 4.0.

1. Insert the CD that comes with the motherboard. Click Intel Chipsets on the left side of the screen. Then select, Intel 845G Chipset Drivers, then Intel 845G Chipset Graphics Driver.



2. When the Welcome screen appears, click Next to continue.

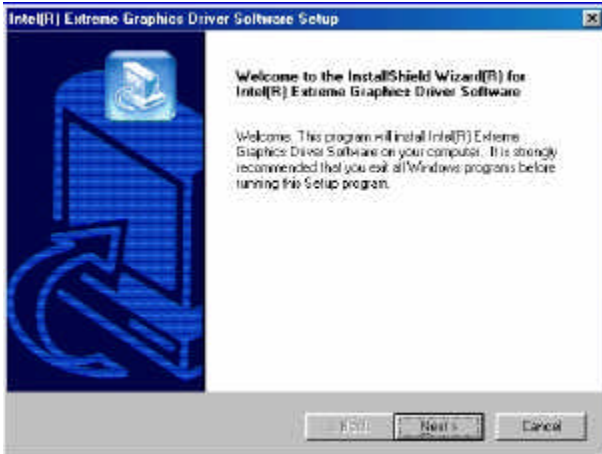

3. Click Yes to accept the software license agreement and proceed with the installation process.

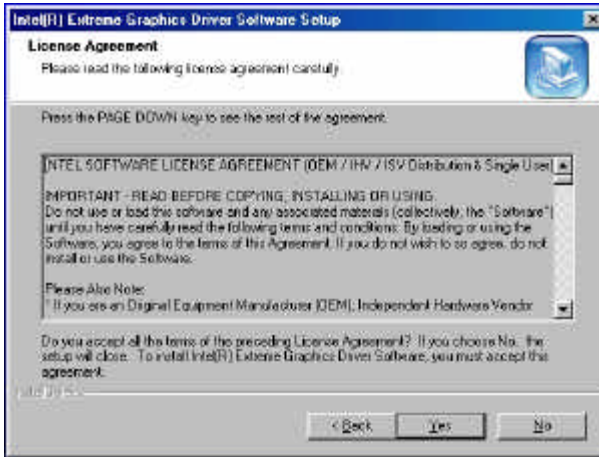

4. The Setup process is now complete. Click Finish to restart the computer and for changes to take effect. Restart your computer when prompted.

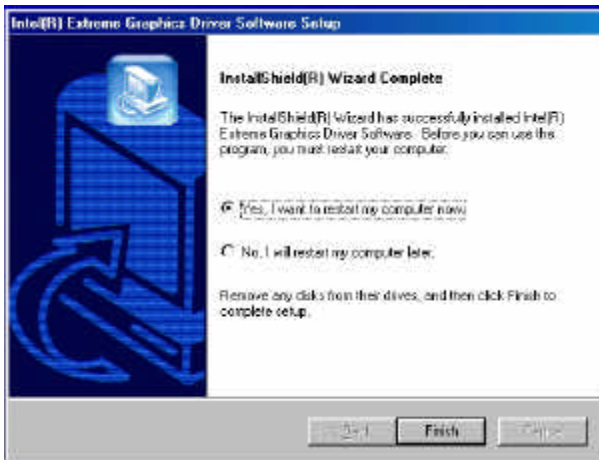

Intel Application Accelerator Installation

Follow the steps below to install Intel Application Accelerator software with the InstallShield Wizard under Windows 98/98SE/ME/2000/XP/NT 4.0.

1. Insert the CD that comes with the motherboard and the screen below would appear. Click Intel Chipsets and then Intel 845G Chipset Drivers.



2. Click Intel Application Accelerator.



3. The Welcome screen of the Install Shield Wizard for Intel Application Accelerator.

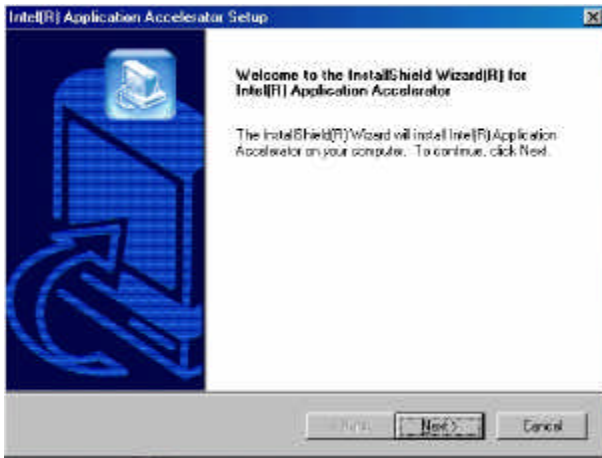

4. Click Yes to accept the software license agreement and proceed with the installation process.

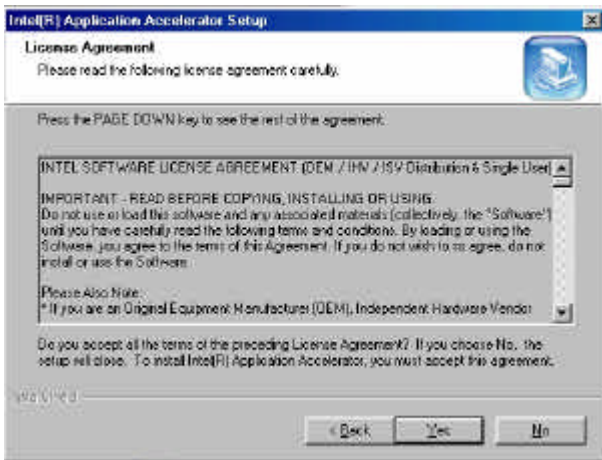

5. You are now required to select the folder where Setup will install files. Click Next to accept the default folder or click Browse to configure the location.

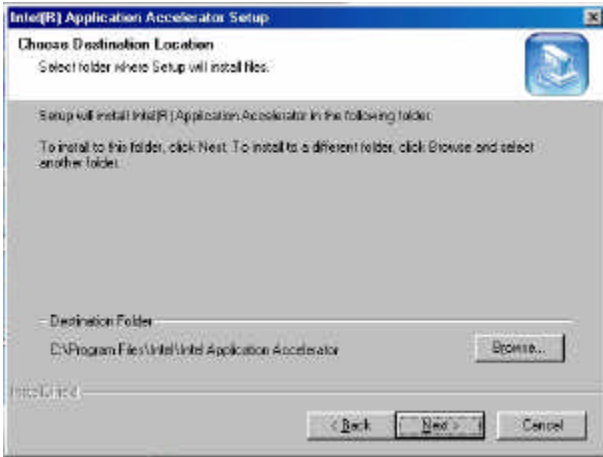

6. You are now asked to select a program folder. Click Next to accept the default program folder or enter the folder name you prefer.

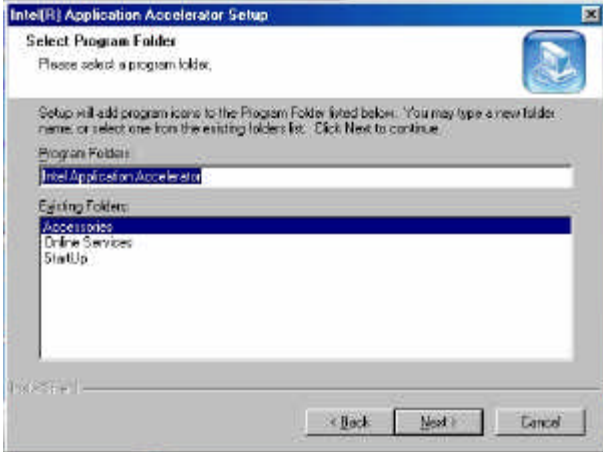

7. The InstallShield Wizard has completed installation. Click Finish for the computer to restart and changes to take effect.

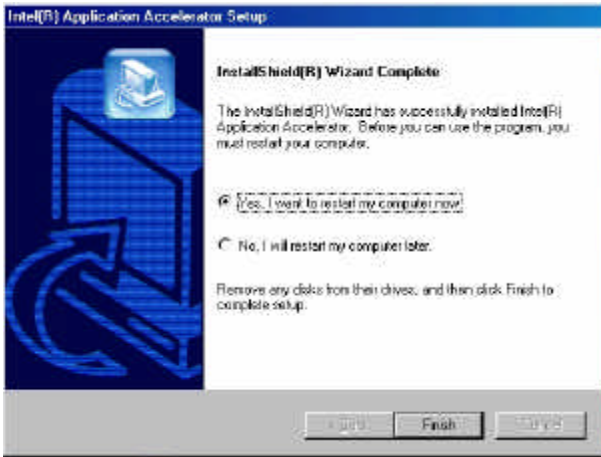

Sigmatel AC97 Codec Audio Driver Installation

Follow the steps below to install SigmaTel AC97 Codec Audio Drivers on your system.

1. Insert the CD that comes with the motherboard and the screen below would appear. Click Intel Chipsets, then Intel 845G Chipset Drivers.

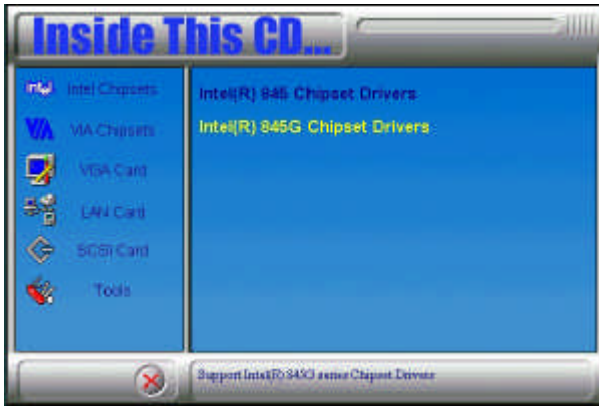

2. Click SigmaTel AC97 Audio Driver.

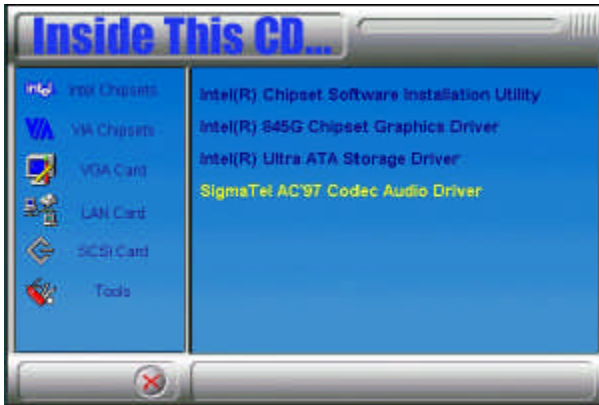

3. The Welcome screen of the SigmaTel AC97 Codec Audio Driver Setup program appears. To continue and start the installation, click Next.

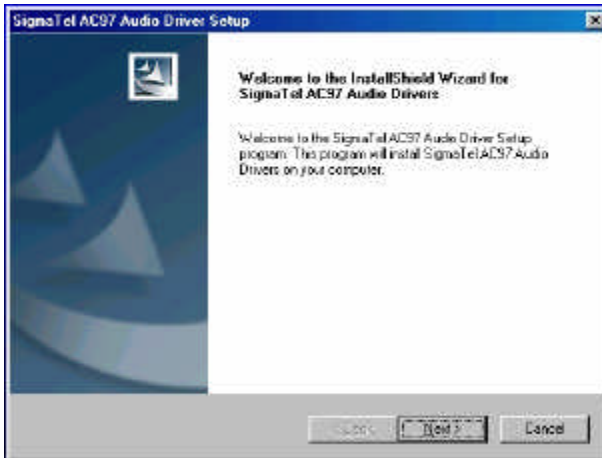

4. Finish to restart the computer and for changes to take effect. .

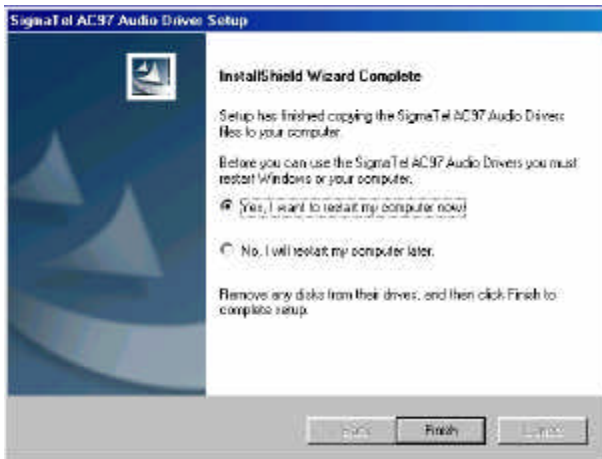

Intel PRO LAN Drivers Installation

The Intel PRO LAN drivers support both Intel® PRO/100 and PRO/1000 drivers. Follow the steps below to complete the installation.

1. Insert the CD that comes with the motherboard and the screen below would appear. Click on LAN Card on the left side to make the LAN drivers selection. Click on Intel(R) PRO LAN Drivers.

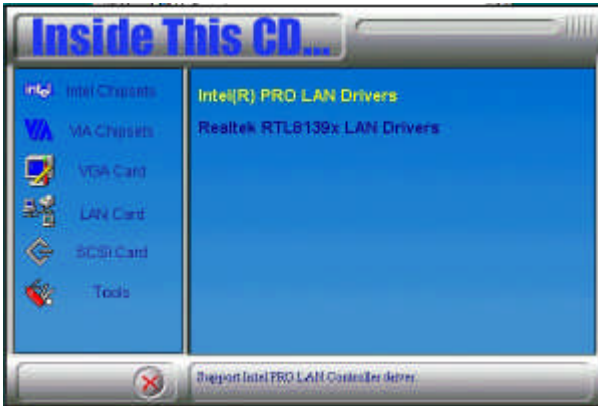

2. Click Install Now.

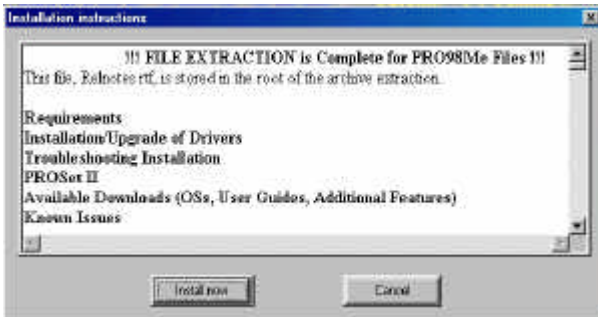

3. Click Restart now to restart the computer and new settings to take effect.



This page is intentionally left blank.

Appendix

A. I/O Port Address Map

Each peripheral device in the system is assigned a set of I/O port addresses which also becomes the identity of the device. The following table lists the I/O port addresses used.

Address	Device Description
000h - 01Fh	DMA Controller #1
020h - 03Fh	Interrupt Controller #1
040h - 05Fh	Timer
060h - 06Fh	Keyboard Controller
070h - 07Fh	Real Time Clock, NMI
080h - 09Fh	DMA Page Register
0A0h - 0BFh	Interrupt Controller #2
0C0h - 0DFh	DMA Controller #2
0F0h	Clear Math Coprocessor Busy Signal
0F1h	Reset Math Coprocessor
1F0h - 1F7h	IDE Interface
278 - 27F	Parallel Port #2(LPT2)
2F8h - 2FFh	Serial Port #2(COM2)
2B0 - 2DF	Graphics adapter Controller
378h - 3FFh	Parallel Port #1(LPT1)
360 - 36F	Network Ports
3B0 - 3BF	Monochrome & Printer adapter
3C0 - 3CF	EGA adapter
3D0 - 3DF	CGA adapter
3F0h - 3F7h	Floppy Disk Controller
3F8h - 3FFh	Serial Port #1(COM1)

B. Interrupt Request Lines (IRQ)

Peripheral devices use interrupt request lines to notify CPU for the service required. The following table shows the IRQ used by the devices on board.

Level	Function
IRQ0	System Timer Output
IRQ1	Keyboard
IRQ2	Interrupt Cascade
IRQ3	Serial Port #2
IRQ4	Serial Port #1
IRQ5	Reserved
IRQ6	Floppy Disk Controller
IRQ7	Parallel Port #1
IRQ8	Real Time Clock
IRQ9	Reserved
IRQ10	Reserved
IRQ11	Reserved
IRQ12	PS/2 Mouse
IRQ13	80287
IRQ14	Primary IDE
IRQ15	Secondary IDE