

PENTIUM

P5I430VX/250



User Manual

PC Main Board

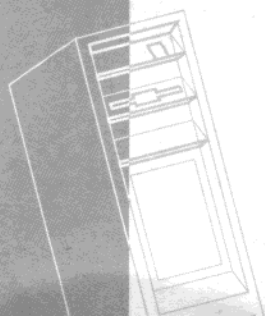
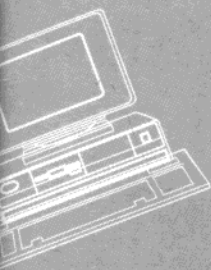

Power Connector

Keyboard Connector

PS2 Mouse Connector

USB2 Connector

USB1 Connector

COM1/COM3

COM2/COM4

IrDA Header

Clear CMOS

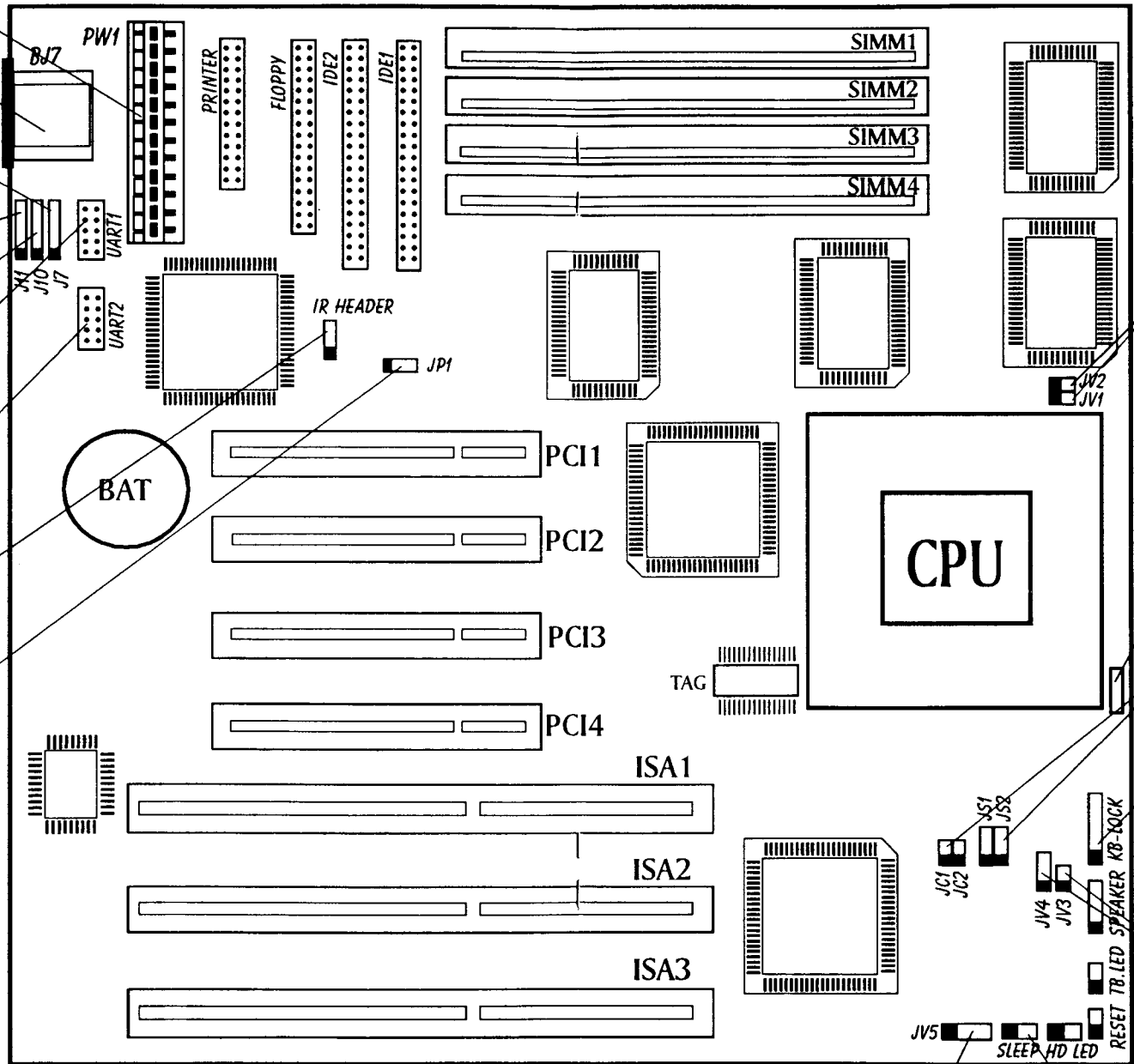

For CPU Type & Voltage Selection

CPU Fan Power Connector

J1, J2, JS1, JS2
CPU Frequency Selection

Keylock Connector

CPU Type & Voltage Selection

For CPU Core Voltage Selection

Hardware Green

CONTENTS

<i>Jumpers Quick Setting</i>	<i>A</i>
1. Introduction	1-1
<i>Overview</i>	1-1
<i>Key Features</i>	1-1
<i>Hardware Settings</i>	1-2
2. Jumper Configuration	2-1
<i>System Clock Selection</i>	2-1
<i>Clock Multiplier Selection</i>	2-2
<i>CPU Frequency Selection</i>	2-2
<i>CPU Type & Voltage Selection</i>	2-6
<i>Clear CMOS</i>	2-7
<i>Memory Configuration</i>	2-7
3. Connector Configuration	3-1
<i>Power Connector</i>	3-1
<i>Keyboard Connector</i>	3-1
<i>Hard Disk LED Connector</i>	3-2
<i>Keylock Connector</i>	3-2
<i>Speaker Connector</i>	3-2
<i>IrDA Connector</i>	3-2
<i>Turbo LED Connector</i>	3-2
<i>CPU Fan Power Connector</i>	3-3
<i>USB Connector</i>	3-3
<i>Reset Switch</i>	3-3
<i>Hardware Green</i>	3-3
<i>PS2 Mouse Connector</i>	3-4

CONTENTS

<i>I/O Port Description</i>	3-4
4. AWARD BIOS Description	4-1
<i>Entering Setup</i>	4-1
<i>Standard CMOS Setup</i>	4-2
<i>BIOS Features Setup</i>	4-4
<i>Chipset Features Setup</i>	4-7
<i>Power Management Setup</i>	4-9
<i>PNP/PCI Configuration</i>	4-12
<i>Load BIOS Defaults</i>	4-13
<i>Load Setup Defaults</i>	4-13
<i>Integrated Peripherals</i>	4-14
<i>Supervisor Password</i>	4-15
<i>User Password</i>	4-15
<i>IDE HDD Auto Detection</i>	4-17
<i>Hard Disk Low Level Format Utility</i>	4-19
<i>Power-On Boot</i>	4-20
5. BIOS Upgrade Diskette	5-1

Jumpers Quick Setting

Install CPU and Cooler

JC1 and JC2 are used for System Clock setting.

JS1 and JS2 are used for CPU multiple clock setting.

(Please refer to page 3-1 ~ page 3-5 in detail informations.)

	CPU FREQUENCY	JC1	JC2	JS1	JS2
Intel Pentium	75MHz	close	close	2-3	2-3
	90MHz	close	open	2-3	2-3
	100MHz	open	close	2-3	2-3
	120MHz	close	open	2-3	1-2
	133MHz	open	close	2-3	1-2
	150MHz	close	open	1-2	1-2
	166MHz	open	close	1-2	1-2
	180MHz	close	open	1-2	2-3
	200MHz	open	close	1-2	2-3
Cyrilx 6x86	P120+	close	close	2-3	1-2
	P133+	open	open	2-3	1-2
	P150+	close	open	2-3	1-2
	P166+	open	close	2-3	1-2
AMD K5	PR75(SSA/5-75)	close	close	2-3	2-3
	PR90(SSA/5-83)	open	open	2-3	2-3
	PR90(SSA/5-90)	close	open	2-3	2-3
	PR100(SSA/5-100)	open	close	2-3	2-3

Jumpers Quick Setting

Select CPU Type & Voltage

JV1, JV2, JV3, JV4 and JV5 are used to select your CPU voltages.
(Please refer to page 3-6 in detail informations.)

	Single Voltage CPU		Dual Voltage CPU				
	Voltage		I/O Voltage		Core Voltage		
	3.3V	3.5V	3.3V	3.5V	2.5V	2.7V	2.9V
JV1	close	close	open	open	----	----	----
JV2	close	close	open	open	----	----	----
JV3	open	close	open	close	----	----	----
JV4	1-2	1-2	2-3	2-3	----	----	----
JV5	----	----	----	----	open	1-2	2-3

Clear CMOS

	CLEAR CMOS	NORMAL
JP1	2-3 (close once)	1-2

On Board Jumpers and Connectors illustration

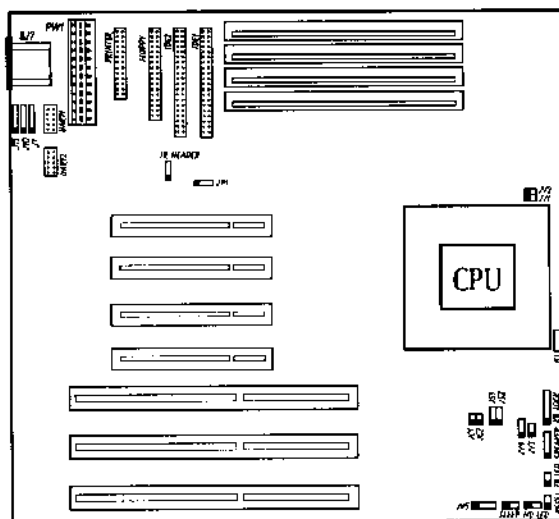

Chapter 1

Introduction

Overview

P5I430VX-250 Explorer green main board provides a highly integrated solution for fully compatible, high performance PC/AT platforms, and supports Intel Pentium, Cyrix 6x86 and AMD K5 microprocessors. It features Write-Back Secondary Cache memory for 256KB/512KB in size. Flexible main memory size can be installed from 8MB up to 128MB DRAMs, so as to give full play to the advantages of the Pentium, Cyrix 6x86 and AMD K5 CPUs. The main board offers a wide range of interface to support integrated on-board IDE and on-board I/O function.

The current Green function is divided into three phases : Doze, Standby and Suspend.

Key Features

- | | |
|---------------------|---|
| <i>CPU</i> | - Supports Intel Pentium 75, 90, 100, 120, 133, 150, 166, 180, 200 MHz and P55C(MMX) CPUs |
| | - Supports P54CTB in specification |
| | - Supports Cyrix 6x86 100, 110, 120, 133MHz CPUs |
| | - Supports AMD K5 CPU |
| | - 2.5V/2.7V/2.9V circuit on board, ready for future P55C compatible support |
| <i>Chipset</i> | - Intel's 82430 VX chipset |
| <i>Main memory</i> | - Supports 4x72pin SIMM modules |
| | - 64-bit data path for flexible memory size expanded from 8MB up to 128M DRAMs on board |
| | - Supports Fast Page mode DRAM (High speed) and EDO DRAM |
| <i>Cache memory</i> | - Supports Write-Back Cache policy for 256KB/512KB L2 Pipelined Burst Cache |
| <i>On-board IDE</i> | - Supports PIO and Bus Master IDE |

Introduction

- Supports up to Mode 4 Timing
- Supports transfer rate up to 22 MByte/s
- Supports 2 Fast IDE interfaces for up to 4 IDE devices including IDE hard disks and CD ROMs
- Green function* - Supports 3 Green modes: Doze, Standby and Suspend
- On-board I/O* - 3 x ISA Slots and 4 x PCI Slots
- Use NS Plug & Play IO chip PC87306
- Supports up to two 3.5" or 5.25" floppy drives 360K/720K/1.2M/1.44M/2.88M format
- All I/O ports can be enabled or disabled
- Two high speed 16550 compatible UARTs (COM1/COM2/COM3/COM4 selectable) with 16-byte send/receive FIFOs and support MIDI mode
- One parallel port at I/O address 378H/278H/3BCH with additional bi-direction I/O capability and multi-mode selection (SPP/EPP/ECP) (IEEE1284 compliant)
- Provides protection circuit to prevent damage to the parallel port when a connected printer is powered up or operated at a higher voltage
- Real-time clock and keyboard controller built-in I/O chip
- Supports PS/2 mouse (Optional)
- Supports IrDA Infrared
- Supports USB (Universal Serial Bus) in specification
- BIOS* - Licensed advanced AWARD BIOS. Supports Flash ROM BIOS, Plug and Play ready. Built-in NCR810 and Adaptec 7850 SCSI drivers
- Board size* - 220mm x 250mm

Hardware Settings

There are some hardware settings on the board. They specify configuration options for various features. The settings are made using something called a 'jumper'. Jumpers on the system board provide information to your operation about installed options and system settings. A jumper is a set of two or more metal pins in a plastic base attached to the mainboard. A plastic jumper 'cap' with a metal plate inside fits over two pins to create an electrical contact between them. The contact establishes a hardware settings such as installing the CPU, selecting cache size.

Note: When you open a jumper, leave the plastic jumper cap attached to one of the pins so you don't lose it.

Jumpers and Caps



Jumper cap

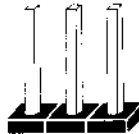

3-pin jumper

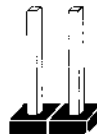

2-pin jumper

Graphic symbol

To rapidly give user a effective and direct way to set jumpers for your system, there are some diagrams used in the following chapters. All kind of jumper setting modes are simplified as the following relevant graphic symbols:



Open all pins of a jumper symbolizes as:



1



closed pin-1 and pin-2 of a jumper symbolizes as:



1

Introduction



closed pin-2 and pin-3 of a jumper
symbolizes as:

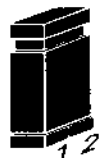

Jumper closed symbolizes as:

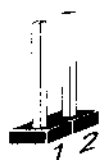

Jumper opened symbolizes as:



Chapter 2

Jumper Configuration

The main board offers a set of jumper settings to facilitate clock frequency adjustment and some important selections.

System Clock Selection

In this P5I430VX-250 Explorer main board, there are four selections of SC (System Clock). User has to set a group of jumpers as the following illustration to determine which system clock used.

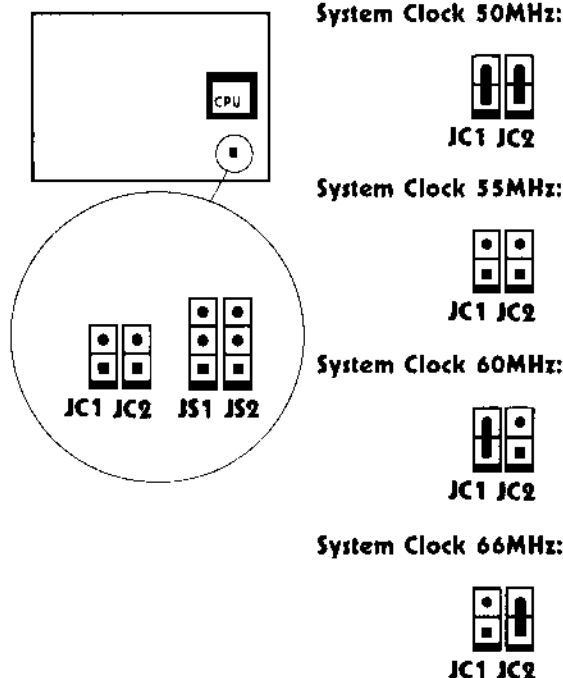

Jumper Configuration

Clock Multiplier Selection

The Intel Pentium CPU multiple clock, settings are shown as follows:

Note: SC – System Clock.

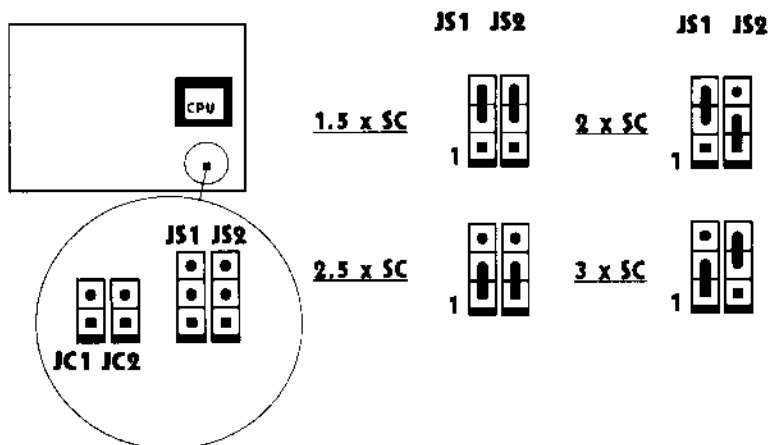

CPU Frequency Selection

According to CPU's specification, set system clock and clock multiplier carefully. The following illustrations list almost all set of jumper settings for the major type CPUs.

For Intel Pentium 75~200MHz

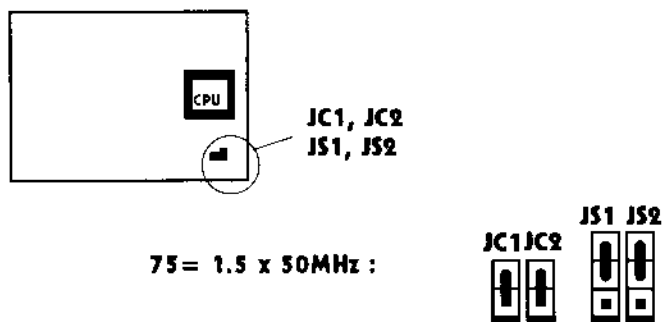

Note: JP4 for AT bus clock ; set open for PCICLK/3, set close for PCICLK/4.

Jumper Configuration

For Cyrix 6x86 CPU

P120+(100MHz)= 2 x 50MHz :



P133+(110MHz)= 2 x 55MHz :

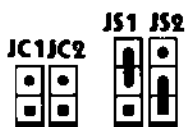

P150+(120MHz)= 2 x 60MHz :

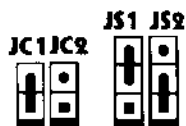

P166+(133MHz)= 2 x 66MHz :

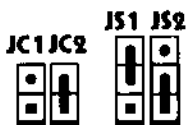

For AMD K5 CPU

PR75 (SSA/5-75) 75MHz
75 = 1.5 x 50MHz :

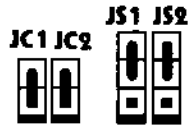

PR90 (SSA/5-83) 83MHz
83 = 1.5 x 55MHz :

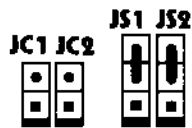

PR90 (SSA/5-90) 90MHz
90 = 1.5 x 60MHz :

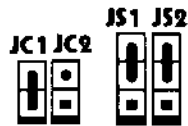

PR100 (SSA/5-100) 100MHz
100 = 1.5 x 66MHz :

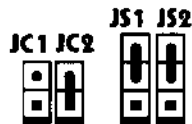

Jumper Configuration

CPU Type & Voltage Selection

For single voltage CPU
(P54C or compatible CPU):

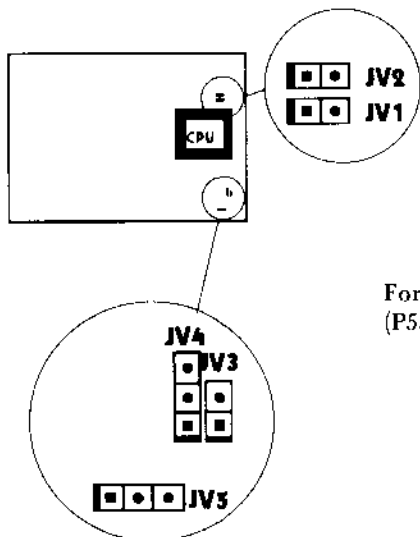

*3.5V voltage

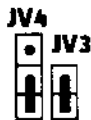

3.3V voltage

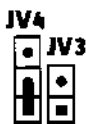

For dual voltage CPU
(P55C or compatible CPU):

I/O voltage selection:

* 3.5V I/O voltage

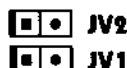

3.3V I/O voltage



Core voltage selection:

* 2.5V core voltage



2.7V core voltage





2.9V core voltage

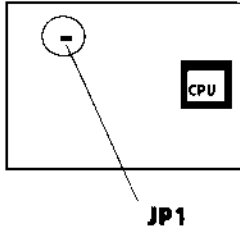

Note: For more information about CPU, please contact with your CPU vendors.

Clear CMOS



Clear CMOS  JP1

Close once

***Normal**  JP1

“*” : Represent for default jumper settings.

Memory Configuration

The P5I430VX-250 Explorer main board supports single-bank 72Pin SIMMs or double-bank 72Pin SIMMs, providing a flexible size from 8MB up to 128MB main memory. The DRAM SIMMs can be installed into either/both SIMM1 & 2 or/and SIMM3 & 4. Please do not plug in two different brands of SIMMs on a bank simultaneously.

RAM SIZE	SIMM1	SIMM2	SIMM3	SIMM4
8 MB	4 MB x 1	4MB x 1	---	---
16 MB	4 MB x 1	4 MB x 1	4 MB x 1	4 MB x 1
16 MB	8 MB x 1	8 MB x 1	---	---
24 MB	8 MB x 1	8 MB x 1	4 MB x 1	4 MB x 1
32 MB	8 MB x 1	8 MB x 1	8 MB x 1	8 MB x 1
32 MB	16 MB x 1	16 MB x 1	---	---
40 MB	16 MB x 1	16 MB x 1	4 MB x 1	4 MB x 1
48 MB	16 MB x 1	16 MB x 1	8 MB x 1	8 MB x 1
64 MB	16 MB x 1	16 MB x 1	16 MB x 1	16MB x 1
64 MB	32 MB x 1	32 MB x 1	---	---
72 MB	32 MB x 1	32 MB x 1	4 MB x 1	4 MB x 1
80 MB	32 MB x 1	32 MB x 1	8 MB x 1	8 MB x 1
96 MB	32 MB x 1	32 MB x 1	16 MB x 1	16 MB x 1
128 MB	32 MB x 1	32 MB x 1	32 MB x 1	32 MB x 1
128 MB	64 MB x 1	64 MB x 1	---	---

Note: Bank 0: SIMM1, SIMM2

Bank 1: SIMM3, SIMM4

Chapter 3

Connector Configuration

This section lists all connector pin assignments and port descriptions on the main board. The situations of the connectors and ports are illustrated in the following figures. Before inserting these connectors, please pay attention to their directions.

Power Connector (PW1)

PIN NUMBER	FUNCTION
1	POWER GOOD
2	+5V
3	+12V
4	-12V
5	GND
6	GND
7	GND
8	GND
9	-5V
10	+5V
11	+5V
12	+5V

Keyboard Connector (BJ7)

PIN NUMBER	FUNCTION
1	CLOCK
2	DATA
3	NC
4	GND
5	+5V

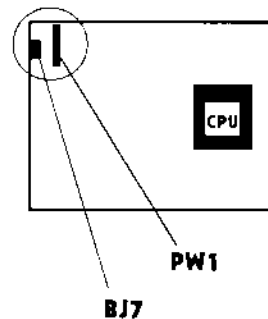

Connector Configuration

Hard Disk LED Connector (HD-LED)

PIN NUMBER	FUNCTION
1	LED ANODE
2	LED CATHODE

Keylock Connector (KB-LOCK)

PIN NUMBER	FUNCTION
1	+5V
2	NC
3	GND
4	KEYLOCK
5	GND

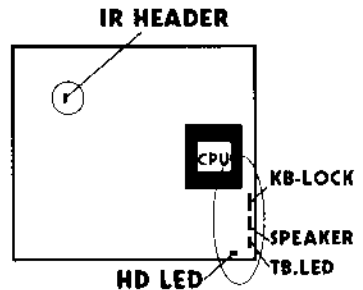

Speaker Connector (SPEAKER)

PIN NUMBER	FUNCTION
1	SPKDATA
2	GND
3	GND
4	VCC

IrDA Connector (IR HEADER)

PIN NUMBER	FUNCTION
1	IRRX
2	GND
3	IRTX
4	VCC

Turbo LED Connector (TB.LED)

PIN NUMBER	FUNCTION
1	LED ANODE
2	LED CATHODE

CPU Fan Power Connector (J13)

PIN NUMBER	FUNCTION
1	GND
2	+12V
3	GND

USB1/USB2 Connector (J10/J11)

PIN NUMBER	FUNCTION
1	VCC
2	Key
3	DATA -
4	DATA+
5	GND

Reset Switch (RESET)

SETTING	FUNCTION
CLOSE ONCE	RESET THE SYSTEM
OPEN	NORMAL

Hardware Green (SLEEP)

SETTING	FUNCTION
CLOSE	HARDWARE GREEN (STOP CLOCK)
OPEN	NORMAL

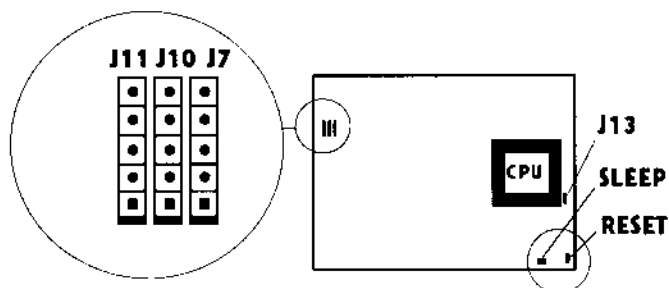

Connector Configuration

PS2 Mouse (J7)

PIN NUMBER	FUNCTION
1	DATA
2	CLOCK
3	GND
4	NC
5	+5V

IO Port Description

CONNECTOR	FUNCTION
IDE 1	Primary IDE Port
IDE 2	Secondary IDE Port
FLOPPY	Floppy Drive Port
PRINTER	Parallel Port
UART 1	COM1/COM3
UART 2	COM2/COM4

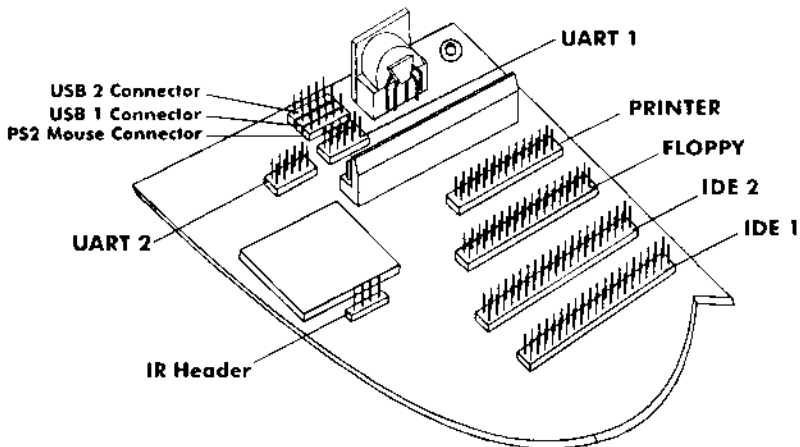

A Part of P51430VX-250 Explorer Main Board

Chapter 4

AWARD BIOS Description

Entering Setup

Power on the computer and press immediately will allow you to enter Setup. The other way to enter Setup is to power on the computer, when the below message appears briefly at the bottom of the screen during the POST (Power On Self Test), press key or simultaneously press <Ctrl> + <Alt> + <Esc> keys.

Press to enter SETUP

Once you enter Award BIOS CMOS Setup Utility, the Main Menu (Figure 1) will be appeared on the screen. The Main Menu allows you to select from twelve setup functions and two exit choices. Use arrow keys to select among the items and press <Enter> to accept or enter the sub-menu.

ROM PCI/ISA BIOS (2A59GQ1A) CMOS SETUP UTILITY AWARD SOFTWARE, INC.	
STANDARD CMOS SETUP	INTEGRATED PERIPHERALS
BIOS FEATURES SETUP	SUPERVISOR PASSWORD
CHIPSET FEATURES SETUP	USER PASSWORD
POWER MANAGEMENT SETUP	IDE HDD AUTO DETECTION
PNP/PCI CONFIGURATION	HDD LOW LEVEL FORMAT
LOAD BIOS DEFAULTS	SAVE & EXIT SETUP
LOAD SETUP DEFAULTS	EXIT WITHOUT SAVING
Esc : Quit	↑↓←→ : Select Item
F10 : Save & Exit Setup	(Shift) F2 : Change Color
Time, Date, Hard Disk Type...	

Figure 1 Main Menu

AWARD BIOS Description

Standard CMOS Setup

Use the arrow keys to highlight the item, then use the <PgUp> or <PgDn> keys to select the value you want in each item.

Date (mm:dd:yy) : Thu, May 14 1996								
Time (hh:mm:ss) : 00:00:00								
HARD DISKS	TYPE	SIZE	CYLS	HEAD	PRECOMP	LANDZ	SECTOR	MODE
Primary Master	: Auto	0	0	0	0	0	0	AUTO
Primary Slave	: Auto	0	0	0	0	0	0	AUTO
Secondary Master	: Auto	0	0	0	0	0	0	AUTO
Secondary Slave	: Auto	0	0	0	0	0	0	AUTO
Drive A	: 1.44M, 3.5 in.				Base Memory : 640K			
Drive B	: None				Extended Memory : 7168K			
Video	: EGA/VGA				Other Memory : 384K			
Halt On	: All Errors				Total Memory : 8192K			
ESC: Quit		↑↓→←	: Select Item		PU/PD/+/- : Modify			
F1 : Help		(Shift) F2	: Change Color					

Figure 2 Standard CMOS Setup Menu

Hard Disk

Primary Master/Primary Slave/Secondary Master/Secondary Slave

The categories identify the types of 2 channels that have been installed in the computer. There are 45 predefined types and 4 user definable types are used for Enhanced IDE BIOS. Type 1 to Type 45 are predefined. Type "User" is user-definable. If your hard disk drive type is not matched with drive table or listed in it, you can use Type "User" to define your own drive type manually.

If you select Type "Auto", BIOS will Auto-Detect the HDD & CD-ROM drive at the POST stage and show the IDE for HDD & CD-ROM drive. If you select Type "User", related information is asked to be entered to the following items. Enter the information directly from the keyboard and press <Enter>:

If the controller of HDD interface is ESDI, the type shall be set to "1".
If the controller of HDD interface is SCSI, the type shall be set to "None".

CYLS	number of cylinders	HEAD	number of heads
PRECOMP	write precomp	LANDZ	landing zone
SECTOR	number of sectors	MODE	HDD access mode

Video

The category selects the type of video adapter used for the primary system monitor. Although secondary monitors are supported, you do not have to select the type in Setup.

EGA/VGA	Enhanced Graphics Adapter/Video Graphic Array. For EGA, VGA, SEGA, or PGA monitor adapters.
CGA 40	Color Graphic Adapter, power up in 40 column mode.
CGA 80	Color Graphic Adapter, power up in 80 column mode.
MONO	Monochrome adapter, includes high resolution monochrome adapters.

Error Halt

The category determines whether the computer will stop if an error is detected during power up.

No errors	The system boot will not be stopped for any error that may be detected.
All errors	Whenever the BIOS detects a non-fatal error, the system will be stopped and you will be prompted.
All, But Keyboard	The system boot will not stop for a keyboard error, but it will stop for all other errors.
All, But Diskette	The system boot will not stop for a disk error; but it will stop for all other errors.
All, But Disk/Key	The system boot will not stop for a keyboard or disk error; but it will stop for all other errors.

AWARD BIOS Description

Memory

The category is display-only which is determined by POST (Power On Self Test) of the BIOS.

Base Memory	The POST of the BIOS will determine the amount of base (or conventional) memory installed in the system.
Extended Memory	The BIOS determines how much extended memory is presented during the POST.
Other Memory	This is memory that can be used for different applications. Most use for this area is Shadow RAM.
Total Memory	The system total memory is the sum of above memory.

BIOS Features Setup

ROM PCI/ISA BIOS (2A59GQ1A)			
BIOS FEATURES SETUP			
AWARD SOFTWARE, INC.			
Virus Warning	: Disabled	Video BIOS Shadow	: Enabled
CPU Internal Cache	: Enabled	C8000~CBFFF Shadow	: Disabled
External Cache	: Enabled	CC000~CFFFF Shadow	: Disabled
Quick Power On Self Test	: Disabled	D0000~D3FFF Shadow	: Disabled
Boot Sequence	: C,A	D4000~D7FFF Shadow	: Disabled
Swap Floppy Drive	: Disabled	D8000~DBFFF Shadow	: Disabled
Boot Up Floppy Seek	: Enabled	DC000~DFFFF Shadow	: Disabled
Boot Up Numlock Status	: On	Delay For HDD (Secs)	: 0
Gate A20 Option	: Fast		
Typematic Rate Setting	: Disabled		
Typematic Rate (Chars/Sec)	: 6		
Typematic Delay (Msec)	: 250		
Security Option	: Setup		
PCI/VGA Palette Snoop	: Disabled	ESC: Quit	^↓→← : Select Item
OS Select For DRAM>64MB	: Non-OS2	F1 : Help	PU/PD/+/- : Modify
		F5 : Old Values (Shift) F2	: Color
		F6 : Load BIOS Default	
		F7 : Load Setup Default	

Figure 3 BIOS Features Setup

The following pages tell you the options of each item and describe the meaning of each option.

Item	Option	Description
Virus Warning	<i>Enabled</i>	Activates automatically when the system boots up causing a warning message to appear when anything attempts to access the boot sector or hard disk partition table.
	<i>Disabled</i>	No warning message to appear when anything attempts to access the boot sector or hard disk partition table. Note: This function is available only for DOS and other OSes that do not trap INT13.
CPU Internal Cache	<i>Enabled, Disabled</i>	This item speeds up memory access. However, it depends on CPU/chipset design. The default value is enabled.
External Cache	<i>Enabled</i>	Enables external cache.
	<i>Disabled</i>	Disables external cache.
Quick Power On Self Test	<i>Enabled</i>	Enables quick POST. BIOS will shorten or skip some check items during POST to speed up POST after you power on the computer.
	<i>Disabled</i>	Normal POST.
Boot Sequence	<i>C,A</i>	The system will firstly search for hard disk drive then floppy disk drive.
	<i>A,C</i>	The system will firstly search for floppy disk drive then hard disk drive.
Swap Floppy Drive	<i>Enabled</i>	It will exchange the assignment of A&B floppy drives.
	<i>Disabled</i>	The assignment of A&B floppy drives are normal.
Boot Up Floppy Seek	<i>Enabled</i>	BIOS searches for floppy disk drive to determine if drive is ready for diskette read/write during booting.
	<i>Disabled</i>	skips drive seeking to speed up system booting.
Boot Up Numlock Status	<i>On</i>	Keypad is used as number keys.
	<i>Off</i>	Keypad is used as arrow keys.
Boot Up System Speed	<i>High</i>	The system will run at high speed after power on.

AWARD BIOS Description

	<i>Low</i>	The system will run at low speed after power on.
Gate A20 Option	<i>Normal</i>	The A20 signal is controlled by keyboard controller or chipset hardware.
	<i>Fast</i>	It is default. The A20 signal is controlled by Port 92 or chipset specific method.
Typematic Rate Setting	<i>Enabled</i>	Enables typematic rate and typematic delay programming.
	<i>Disabled</i>	Disables typematic rate and typematic delay programming. The system BIOS will use default value of these two items.
Typematic Rate (Chars/Sec)	<i>6 ~ 30</i>	Set the speed of the typematic rate (characters per second).
Typematic Delay (Msec)	<i>250~1000</i>	Set the time of the typematic delay
Security Option	<i>System</i>	The system will not boot and access to Setup will be denied if the correct password is not entered at the prompt.
	<i>Setup</i>	The system will boot, but access to Setup will be denied if the correct password is not entered at the prompt. Note: To disable security, select PASSWORD SETTING at Main Menu and then you will be asked to enter password. Do not type anything and just press <Enter>, it will disable security. Once the security is disabled, the system will boot and you can enter Setup freely.
PCI/VGA Palette Snoop	<i>Enabled</i>	Enables PCI/VGA palette snoop.
	<i>Disabled</i>	Disables PCI/VGA palette snoop.
OS Select For DRAM>64MB	<i>Non-OS/2</i>	If your operating system is not OS/2, please select this item.
	<i>OS/2</i>	If system DRAM is more than 64MB and operating system is OS/2, please select this item.
Video BIOS Shadow	<i>Enabled</i>	Video BIOS will be copied to RAM. Video Shadow will increase the video speed.
	<i>Disabled</i>	Video shadow is disabled.
C8000~CBFFF Shadow /	<i>Enabled</i>	Option shadow is enabled. Optional ROM will be copied to RAM by 16K byte per unit.
DC000~DFFFF Shadow	<i>Disabled</i>	The shadow function is disabled.

Delay For HDD(Secs) 0~15 This item allows you to set additional delay time (0~15 seconds) for HDD detection. If you find HDD detection problem, you may try to add delay time.

Chipset Features Setup

ROM PCI/ISA BIOS (2A59GQ1A)	
CHIPSET FEATURES SETUP	
AWARD SOFTWARE, INC.	
Auto Configuration	: Enabled
DRAM Timing	: 70ns
DRAM RAS# Precharge Time	: 4
DRAM R/W Leadoff Timing	: 6
Fast RAS To CAS Delay	: 3
DRAM Read Burst (EDO/FP)	: x333/x444
DRAM Write Burst Timing	: x333
Fast MA to RAS# Delay CLK	: 1
Fast EDO Path Select	: Disabled
Refresh RAS# Assertion	: 5 Clks
ISA Bus Clock	: PCICLK/4
System BIOS Cacheable	: Disabled
Video BIOS Cacheable	: Disabled
8 Bit I/O Recovery Time	: 1
16 Bit I/O Recovery Time	: 1
Memory Hole At 15M-16M	: Disabled
Peer Concurrency	: Enabled
Chipset NA# Asserted	: Enabled
ESC: Quit ↑↓→← : Select Item F1 : Help PU/PD/+/- : Modify F5 : Old Values (Shift)F2 : Color F6 : Load BIOS Default F7 : Load Setup Default	

Figure 4 Chipset Features Setup

AWARD BIOS Description

The following pages tell you the option of each item and describe the meanings of each option.

Item	Option	Description
Auto Configuration	<i>Enabled</i>	Enables auto configuration of DRAM timing
DRAM Timing	<i>60ns</i> <i>70ns</i>	This item is of selected DRAM read/write timing. You must ensure that your SIMMs is as fast as 60ns, otherwise you have to select 70ns.
<i>DRAM RAS# Precharge Time ~ ISA Bus Clock :</i>		
All these items are about DRAM Timing and show-only for user reference.		
System BIOS Cacheable	<i>Enabled</i> <i>Disabled</i>	Besides conventional memory, the system BIOS area is also cacheable. The system BIOS area is not cacheable.
Video BIOS Cacheable	<i>Enabled</i> <i>Disabled</i>	Besides conventional memory, video BIOS area is also cacheable. Video BIOS area is not cacheable.
8 Bit I/O Recovery Time	<i>1-4</i> <i>NA</i>	It is the ISA Bus 8 bit I/O operating recovery time. 8 bit I/O recovery time is not exist.
16 Bit I/O Recovery Time	<i>1-8</i> <i>NA</i>	It is the ISA Bus 16 bit I/O operating recovery time. 16 bit I/O recovery time is not exist.
Memory Hole at 15M~16M	<i>Enabled</i> <i>Disabled</i>	Memory Hole at 15M~16M is reserved for expanded PCI card. Do not set this memory hole.
Peer Concurrency/ Chipset NA# Asserted	<i>Enabled,</i> <i>Disabled</i>	These items enabled will accelerate operation speed of PCI bus, thus benefit to the system performance. But perhaps don't support some expanded cards.

Power Management Setup

ROM PCI/ISA BIOS (2A59GQ1A) POWER MANAGEMENT SETUP AWARD SOFTWARE, INC.		
Power Management	: Disable	** Wake up Events In Suspend **
PM Control by APM	: Yes	IRQ3 (COM2) : ON
Video Off Method	: V/H SYNC + Blank	IRQ4 (COM1) : ON
Video Off Option	: Susp, Sby>Off	IRQ5 (LPT 2) : ON
Doze Mode	: Disabled	IRQ6 (Floppy Disk) : ON
Standby Mode	: Disabled	IRQ7 (LPT1) : ON
Suspend Mode	: Disabled	IRQ8 (RTC Alarm) : OFF
HDD Power Down	: Disabled	IRQ9 (IRQ2 Redir) : OFF
		IRQ10 (Reserved) : OFF
		IRQ11 (Reserved) : OFF
** Wake up Events In Doze & Standby **		IRQ12 (PS/2 Mouse) : ON
IRQ3 (Wake-Up Event)	: ON	IRQ13 (Coprocessor) : OFF
IRQ4 (Wake-Up Event)	: ON	IRQ14 (Hard Disk) : ON
IRQ8 (Wake-Up Event)	: ON	IRQ15 (Reserved) : ON
IRQ12 (Wake-Up Event)	: ON	ESC: Quit ↑↓→← : Select Item
		F1 : Help PU/PD/+/- : Modify
		F5 : Old Values (Shift)F2 : Color
		F6 : Load BIOS Default
		F7 : Load Setup Default

Figure 5 Power Management Setup

The following pages tell you the option of each item and describe the meanings of each option.

Item	Option	Description
Power Management	<i>Disabled</i>	Global Power Management will be disabled.
	<i>User Define</i>	Users can configure their own Power Management Timer.
	<i>Min Saving</i>	Pre-defined timer values are used such that all timers are in their MAX values.

AWARD BIOS Description

	<i>Max Saving</i>	Pre-defined timer values are used such that all timers are in their MIN values.
PM Control by APM	<i>No</i>	System BIOS will ignore APM when power managing the system.
	<i>Yes</i>	System BIOS will wait for APM's prompt before it enter any PM mode, such as Standby or Suspend. Note: If APM is installed, and if there is a task running, even the timer is time out, the APM will not prompt the BIOS to put the system into any power saving mode. But if APM is not installed, this option has no effect.
Video Off Method	<i>Blank Screen</i>	The system BIOS will only blank off the screen when disabling video.
	<i>VH SYNC+ Blank</i>	In addition to Blank Screen, BIOS will also turn off the V-SYNC & H-SYNC signals from VGA cards to monitor.
	<i>DPMS</i>	This function is enabled for only the VGA card supporting DPMS. Note: Green monitors detect the VH-SYNC signals to turn off its electron gun.
Video Off Option	<i>Always On</i>	System BIOS will never turn off the screen.
	<i>Suspend->Off</i>	Screen off when system is in Suspend mode.
	<i>Susp, Stby->Off</i>	Screen off when system is in Standby or Suspend mode.
Doze Mode	<i>All Modes->Off</i>	Screen off when system is in Standby or Suspend mode.
	<i>Disabled</i>	The system will never enter Doze mode.
	<i>1 Min ~ 1 Hr</i>	Defines the continuous idle time before the system entering Doze mode. If any item defined in "Wake Up Events In Doze & Suspend" is On and activated, the system will be waken up.
Standby Mode	<i>Disabled</i>	The system will never enter Standby mode.

	<i>1 Min ~ 1 Hr</i>	Defines the continuous idle time before the system entering Standby mode. If any item defined in "Wake Up Events In Doze & Standby" is On and activated, the system will be waken up.
Suspend Mode	<i>Disabled</i>	The system will never enter Suspend mode.
	<i>1 Min ~ 1 Hr</i>	Defines the continuous idle time before the system entering Suspend mode. If any item defined in "Wake Up Events In Suspend" is On and activated, the system will be waken up.
HDD Power Down	<i>Disabled</i>	HDD's motor will not be off.
	<i>1Min~15Min</i>	Defines the continuous HDD idle time before the HDD entering power saving mode (motor off).
IRQ3 ~ 12 (Doze & Standby)	<i>OFF</i>	The specified event's activity will not make the system wake up from Doze & Standby mode.
	<i>ON</i>	The specified event's activity will make the system wake up from Doze & Standby mode.
IRQ3 ~ IRQ15 (Suspend)	<i>OFF</i>	The specified event's activity will not make the system wake up from Suspend mode.
	<i>ON</i>	The specified event's activity will make the system wake up from Suspend mode.

AWARD BIOS Description

PNP/PCI Configuration

ROM PCI/ISA BIOS (2A59GQ1A)	
PNP/PCI CONFIGURATION	
AWARD SOFTWARE, INC.	
Resources Controlled By : Manual	PCI IRQ Active By : Level
Force Update ESCD : Disabled	PCI IDE IRQ Map To : PCI-AUTO
	Primary IDE INT# : A
	Secondary IDE INT# : B
IRQ-3 assigned to : Legacy ISA	
IRQ-4 assigned to : Legacy ISA	
IRQ-5 assigned to : PCI/ISA PnP	
IRQ-7 assigned to : Legacy ISA	
IRQ-9 assigned to : PCI/ISA PnP	
IRQ-10 assigned to : PCI/ISA PnP	
IRQ-11 assigned to : PCI/ISA PnP	
IRQ-12 assigned to : PCI/ISA PnP	
IRQ-14 assigned to : Legacy ISA	
IRQ-15 assigned to : Legacy ISA	
DMA-0 assigned to : PCI/ISA PnP	
DMA-1 assigned to : PCI/ISA PnP	
DMA-3 assigned to : PCI/ISA PnP	ESC: Quit ↑↓→← : Select Item
DMA-4 assigned to : PCI/ISA PnP	F1 : Help PU/PD/+/- : Modify
DMA-5 assigned to : PCI/ISA PnP	F5 : Old Values (Shift)F2 : Color
DMA-6 assigned to : PCI/ISA PnP	F6 : Load BIOS Default
DMA-7 assigned to : PCI/ISA PnP	F7 : Load Setup Default

Figure 6 PNP/PCI Configuration Setup

The following pages tell you the options of each item and describe the meaning of each option.

Item	Option	Description
Resources Controlled By	<i>Manual</i>	Assigns system resources (IRQ and DMA) manually by user.
	<i>Auto</i>	Assigns system resources (IRQ and DMA) automatically by BIOS.
Force Updating ESCD	<i>Enabled</i>	The system BIOS will force updating ESCD once, then automatically set this item Disable.

	<i>Disabled</i>	Disables force update ESCD function.
IRQ-3 ~ IRQ-15 assigned to	<i>Legacy ISA</i>	The specified IRQ-x will be assigned to ISA only.
	<i>PCI/ISA PnP</i>	The specified IRQ-x will be assigned to ISA or PCI.
DMA-0 ~ DMA-7 assigned to	<i>Legacy ISA</i>	The specified DMA-x will be assigned to ISA only.
	<i>PCI/ISA PnP</i>	The specified DMA-x will be assigned to ISA or PCI.
PCI IRQ Active By	<i>Level, Edge</i>	To tell the chipset that the IRQ signals input is level or edge trigger.
PCI IDE IRQ Map To	<i>PCI-AUTO</i>	The BIOS will scan for PCI IDE devices and determine the location of the PCI IDE device.
	<i>PCI-SLOT 1-4</i>	The BIOS will assign IRQ 14 for primary IDE INT# and IRQ15 for secondary IDE INT# for the specified slot.
	<i>ISA</i>	The BIOS will not assign any IRQs even if PCI IDE card is found. Because some IDE cards connect the IRQ 14&15 directly from ISA slot through a card.
Primary IDE INT#	<i>A~D</i>	To tell which INT# the PCI IDE card is used for its interrupt of 1st IDE channel.
Secondary IDE INT#	<i>A~D</i>	To tell which INT# the PCI IDE card is used for its interrupt of 2nd IDE channel.

Load BIOS Defaults

The BIOS Defaults is conventional and safe setting.

Load Setup Defaults

The Setup Defaults is common and efficient setting.

AWARD BIOS Description

Integrated Peripherals

ROM PCI/ISA BIOS (2A59GQ1A) INTEGRATED PERIPHERALS AWARD SOFTWARE, INC.	
IDE HDD Block Mode	: Enabled
IDE Primary Master PIO	: Auto
IDE Primary Slave PIO	: Auto
IDE Secondary Master PIO	: Auto
IDE Secondary Slave PIO	: Auto
On-Chip Primary PCI IDE	: Enabled
On-Chip Secondary PCI IDE	: Enabled
PCI Slot IDE 2nd Channel	: Enabled
Onboard FDC Controller	: Enabled
Onboard Serial Port 1	: COM1/3F8
Onboard Serial Port 2	: COM2/2F8
Onboard Parallel Port	: 378H/IRQ7
Parallel Port Mode	: Compatible
Infrared Duplex Type	: Disabled
ESC: Quit ↑↓→← : Select Item F1 : Help PU/PD/+/- : Modify F5 : Old Values (Shift)F2 : Color F6 : Load BIOS Default F7 : Load Setup Default	

Figure 7 Integrated Peripherals

The following pages tell you the options of each item and describe the meaning of each option.

Item	Option	Description
IDE HDD Block Mode	<i>Enabled</i>	Allows IDE HDD read/write several sectors one time.
	<i>Disabled</i>	IDE HDD only reads/writes a sector one time.
IDE Primary /Secondary Master /Slave PIO	<i>Mode 0~4</i>	Defines the IDE primary/secondary master/slave PIO mode.

	<i>Auto</i>	The IDE PIO mode is defined according to auto-detect.
On-chip Primary/ Secondary PCI IDE	<i>Enabled</i>	On-chip primary/secondary PCI IDE port is enabled.
	<i>Disabled</i>	On-chip primary/secondary PCI IDE port is disabled.
PCI Slot IDE 2nd Channel	<i>Enabled</i>	The second IDE channel on PCI slot is enabled.
	<i>Disable</i>	The second IDE channel on PCI slot is disabled.
Onboard FDC Controller	<i>Enabled</i>	Onboard floppy disk is enabled.
	<i>Disabled</i>	Onboard floppy disk is disabled.
Onboard Serial Port 1/2	<i>COM1/3F8,</i>	Defines onboard serial port address.
	<i>COM2/2F8,</i>	
	<i>COM3/3E8,</i> <i>COM4/2E8</i>	
Onboard Parallel Port	<i>Disabled</i>	Onboard serial port is disabled.
	<i>378/IRQ5,</i> <i>278/IRQ5,</i> <i>3BC/IRQ7,</i> <i>378/IRQ7</i>	Defines onboard parallel port address and IRQ channel.
Parallel Port Mode	<i>Disabled</i>	Onboard parallel port is disabled.
	<i>Compatible,</i> <i>Extended,</i> <i>EPP,</i> <i>ECP</i>	Defines the parallel port mode is Standard Parallel Port (SPP), Enhanced Parallel Port (EPP), or Extended Capabilities Port (ECP). Both Compatible mode and Extended mode are SPP mode, except that the later has a latchable buffer between I/O data pins and CPU.
Infrared Duplex	<i>Disabled,</i> <i>Half,</i> <i>Full</i>	Defines Infrared communication mode: disabled, half-duplex, or full-duplex.

Supervisor/User Password

When you select *Supervisor/User Password* function, the following message will appear at the center of the screen to assist you in creating a password.

ENTER PASSWORD

Type the password, up to eight characters, and press <Enter>. The password typed now will clear any previously entered password from CMOS memory. You will be asked to confirm the password. Type the password again and press <Enter>. You may also press <Esc> to abort the selection and not enter a password.

To disable password, just press <Enter> when you are prompted to enter password. The following message will confirm the password being disabled. If both Supervisor and User Password are disabled, the system will boot and you can enter CMOS Setup freely.

PASSWORD DISABLED

If you select "System" at "Security Option" of "BIOS Features Setup" Menu, you will be prompted for the password every time the system is rebooted or any time you try to enter "CMOS Setup".

If you select "Setup" at "Security Option" of "BIOS Features Setup" Menu, you will be prompted only when you try to enter "CMOS Setup".

Supervisor Password has higher priority than *User Password*. You can use *Supervisor Password* when booting system or entering "CMOS Setup" to modify all settings. Also you can use *User Password* when booting system or entering "CMOS Setup" but can not modify any setting if *Supervisor Password* is enabled.

IDE HDD Auto Detection

The Enhance IDE features was included in all Award BIOS. Below is a brief description of this features.

ROM PCI/ISA BIOS (2A59GQ1A)							
CMOS SETUP UTILITY							
AWARD SOFTWARE, INC.							
HARD DISKS TYPE SIZE CYLS HEAD PRECOMP LANDZ SECTOR MODE							
Primary Master:							
Select Primary Master Option (N = Skip) : N							
OPTIONS	SIZE	CYLS	HEADS	PRECOMP	LANDZONE	SECTOR	MODE
1(Y)	516	1120	16	65535	1119	59	NORMAL
2	516	524	32	0	1119	63	LBA
3	516	560	32	65536	1119	59	LARGE
Note: Some OSeS (like SCO-UNIX) must use "NORMAL" for installation							

Figure 8 IDE HDD Auto Detection

1. Setup Changes

With auto-detection

- BIOS setup will display all possible modes that is supported by the HDD including NORMAL, LBA & LARGE.
- If HDD does not support LBA modes, no "LBA" option will be shown.
- If number of cylinders is less than or equal to 1024, no "LARGE" option will be shown.
- Users can select a mode which is appropriate for them.

With Standard CMOS Setup

	CYLS	HEADS	PRECOMP	LAND ZONE	SECTOR	MODE
Drive C : User(516MB)	1120	16	65535	1119	59	NORMAL
Drive D : None(203MB)	684	16	65535	685	38	-----

When HDD type is in "user" type, the "MODE" option will be opened for user to select their own HDD mode.

AWARD BIOS Description

2. HDD Modes

The Award BIOS supports 3 HDD modes: NORMAL, LBA and LARGE, and Auto detect.

NORMAL

Generic access mode in which neither the BIOS nor the IDE controller will make any transformation during accessing. The maximum number of cylinder, head and sectors for NORMAL mode are 1024, 16 and 63.

If user set his HDD to NORMAL mode, the maximum accessible HDD size will be 528 Megabytes even though its physical size may be greater than that.

LBA (Logical Block Addressing) mode

A new HDD accessing method to overcome the 528 Megabyte bottleneck. The number of cylinders, head and sectors shown in setup may not be the number physically contained in the HDD.

During HDD accessing, the IDE controller will transform the logical address described by sector, head and cylinder number into its own physical address inside the HDD. The maximum HDD size supported by LBA mode is 8.4 Gigabytes.

LARGE mode

Some IDE HDDs contain more than 1024 cylinder without LBA support (in some cases, user do not wait LBA). The Award BIOS provides another alternative to support these kinds of HDD.

BIOS tricks DOS (or other OS) that the number of cylinders is less than 1024 by dividing it by 2. At the same time, the number of heads is multiplied by 2. A reverse transformation process will be made inside INT13h in order to access the right HDD address.

Auto detect

If using Auto detect, the BIOS will auto detect IDE hard disk mode and set it to one kind of HDD modes.

3. Remark

To support LBA or LARGE mode of HDDs, there must be some software involved. All these software are located in the Award HDD Service Routine (INT 13h). It may be failed to access a HDD with LBA (LARGE) mode selected if you are running under a Operating System which replaces the whole INT 13h.

Hard Disk Low Level Format Utility

This Award Low-Level-Format Utility is designed as a tool to save your time formatting your disk. The Utility automatically looks for the necessary information of the drive you selected. Utility also searches for bad tracks and list them for your reference.

Shown below is the Main Menu after you enter into the Award Low-Level-Format Utility.

Hard Disk Low-Level-Format Utility		NO. CYLS HEAD					
SELECT DRIVE							
BAD TRACK LIST							
PREFORMAT							
Current select drive is : C							
DRIVE : C CYLINDER : 0 HEAD : 0							
	SIZE	CYL.	HEAD	PRECOMP	LANDZ	SECTORS	MODE
Primary Master	: 40MB	977	5	300	977	17	NORMAL
Primary Slave	: None	0	0	0	0	0	AUTO
Secondary Master	: None	0	0	0	0	0	AUTO
Secondary Slave	: None	0	0	0	0	0	AUTO
Up/Down - Select item		Enter - Accept		ESC - Exit/Abort			
Copyright (c) Award Software, Inc. 1992-1994 All Rights Reserved							

Figure 9 Hard Disk Low Level Format Utility

SELECT DRIVE

Select from installed hard disk drive C or D. List at the bottom of the screen is the drive automatically detected by the utility.

AWARD BIOS Description

BAD TRACK LIST

Auto scan bad track

The utility will automatically scan bad tracks and list the bad tracks in the window at the right side of the screen.

Add bad track

Directly type in the information of the known bad tracks in the window at the right side of the screen.

Modify bad track

Modify the information of the added bad tracks in the window at the right side of the screen.

Delete bad track

Delete the added bad tracks in the window at the right side of the screen.

Clear bad track table

Clear the whole bad track list in the window at the right side of the screen.

PREFORMAT

Interleave

Select the interleave number of the hard disk drive you wish to perform low level format. You must select from 1 to 8. Check the documentation that came with the drive for the correct interleave number, or select 0 for utility automatic detection.

Auto scan bad track

This allows the utility to scan bad track or not.

Start

Press <Y> to start low level format.

Power-On Boot

After you have made all the changes to CMOS values and the system cannot boot with the CMOS values selected in Setup, restart the system by turning it OFF then ON or pressing the "RESET" button on the system case.

You may also restart by simultaneously press <Ctrl>, <Alt>, and <Delete> keys.

Appendix

BIOS Upgrade Diskette

You can use this diskette to update your BIOS.

For the most update and additional information about BIOS upgrade, please refer to "README" in the "BIOS Upgrade Diskette".

Warning: Before you update your BIOS, you should look over the "README" file to avoid making mistake.



P/N: 430-01008-603
Manual P5I430VX-250 Explorer Ver 3.0