

## Installation Procedures

The motherboard has several user-adjustable jumpers on the board that allow you to configure your system to suit your requirements. To set up your computer, you should follow these installation steps: 1). set system jumpers; 2). install RAM modules; 3). install the CPU; 4). install expansion cards; 5). connect cables and power supply; 6). set up BIOS feature. 7). set up supporting software tools.

**CAUTION** : If you use an electric drill to install this motherboard on your chassis, please wear a static wrist strap. The recommended electric drill torque is from 5.0 to 8.0 kg/cm to avoid damaging the chips' pins.

### 1). Set System Jumpers

#### Jumpers

Jumpers are used to select the operation modes for your system. To **set** a jumper, a black cap containing metal contacts is placed over the jumper pins according to the required configuration. A jumper is said to be **shorted** when the black cap has been placed on one or two of its pins. The types of jumpers used in this manual are shown below:

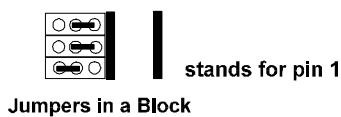
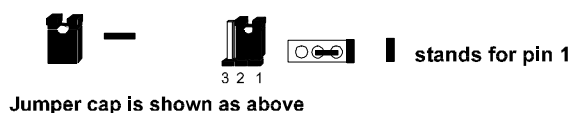

**NOTE** : Users are not encouraged to change the jumper settings not listed in this manual. Changing the jumper settings improperly may adversely affect system performance.

## Motherboard Layout

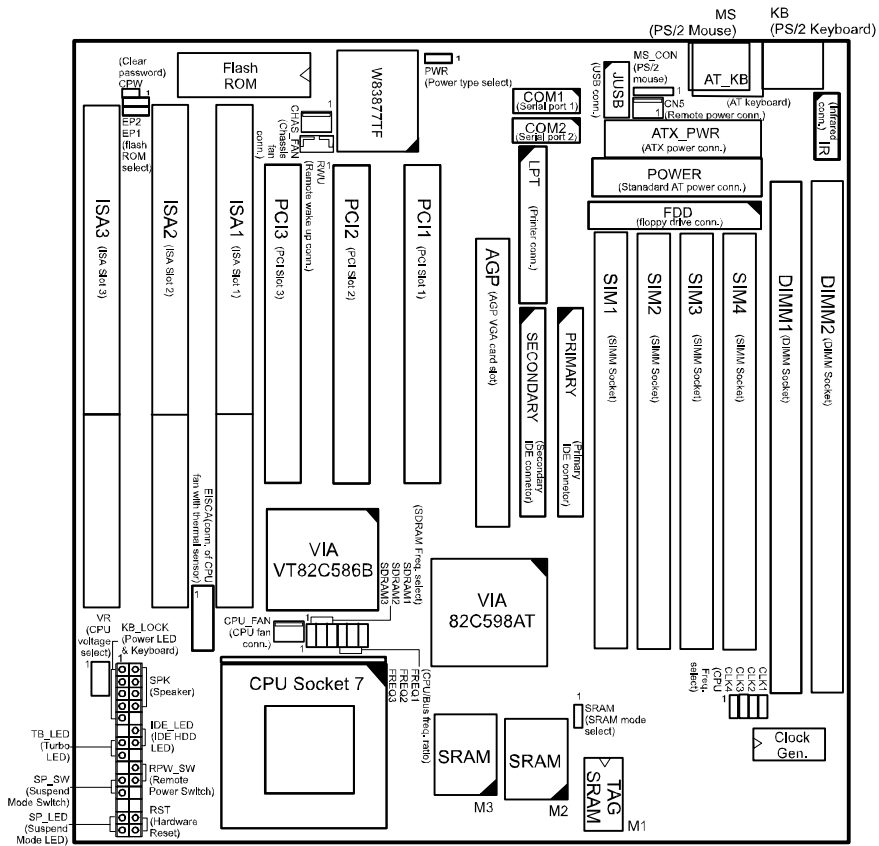

## Installation Procedures

---

Onboard Mark	Meaning	Page
CPW	Clear Password	10
EP1, 2	Flash ROM Type Selection	10
PWR	Power Supply Type Selection	11
SRAM	CPU to SRAM Data Transacting Mode Selection	11
SDRAM1, 2, 3; CLK4	DIMM Frequency Selection	15
CLK1, 2, 3	CPU External (Bus) Frequency Selection	18
FREQ1, 2, 3	CPU to Bus Frequency Ratio Selection	18
VR	CPU Voltage Selection	20
DIMM1, 2; SIMM 1, 2, 3, 4	Memory Module Socket	12
CPU ZIF Socket 7	ZIF Socket7 for Processor	17
AGP	Accelerated Graphic Port Slot	21
PCI1, 2, 3	PCI Bus Expansion Slot (32-bit)	21
ISA1, 2, 3	ISA Bus Expansion Slot (16-bit)	21
AT_KB	AT Keyboard Connector	22
COM1, 2	Serial Port	22
JUSB	Universal Serial Bus Connector	22
LPT	Parallel Port	23
EICA	EISCA CPU Fan Connector	23
CPU_FAN	CPU Fan Connector	23
FDD	Floppy Diskette Drive Connector	24
CN5	Remote Power Connector for AT power supply with remote feature (It allows soft power off in Win 95)	24
PRIMARY, SECONDRAY	IDE Device Connector	24
MS_CON	PS/2 Mouse Connector	25
IR	Infrared Connector	25
CHAS_FAN	System Case (Chassis) Fan Connector	25
F_PNL*	Connectors for LEDs & Switches on Front Panel	26
KB	PS/2 Keyboard Connector (manufacturing optional)	27
MS	PS/2 Mouse Connector (manufacturing optional)	27
POWER	AT Power Connector	28
ATX_PWR	ATX Power Connector	28
RWU	Remote Wake Up Connector	28

*\* includes PW\_LED, KB\_LOCK, TB\_LED, SP\_SW, SPK, SP\_LED, IDE\_LED, RPW\_SW, and RST connectors. (Please read Page 26 for detail information.)*

***Clear Password: CPW***

This jumper allows you to set the password configuration to Enabled or Disabled. You may need to enable this jumper if you forget your BIOS-level password.

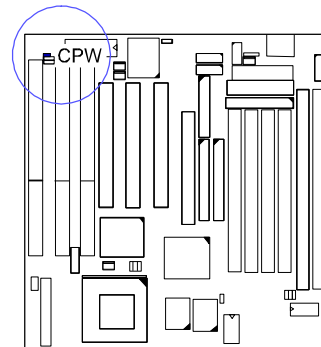
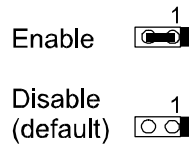

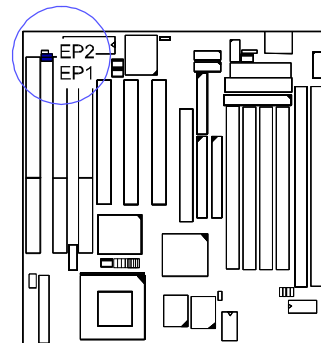
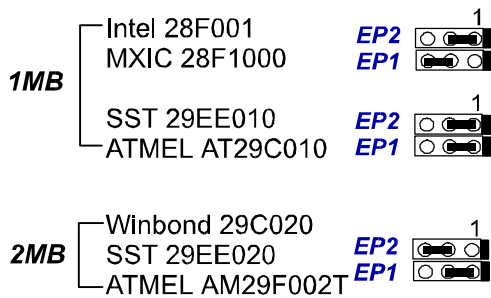

***Flash ROM Type Selection: EP1, EP2***

These two jumpers allow you to configure the type of flash ROM chip. This jumper setting is correct by manufactory default. If you want to know the flash ROM type installed on this motherboard, remove the sticker from the chip to see its type.



***Power Supply Type Selection: PWR***

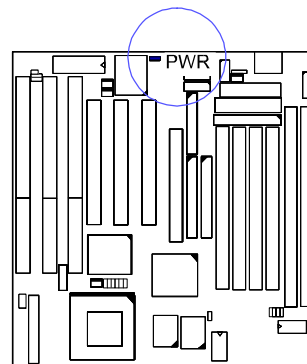

This jumper allows you to select the power supply type that you use: an AT or ATX power supply while both power supply connectors onboard. If only one type of power supply connector onboard, this jumper will be wired by the manufacturer.

-   
ATX Power Supply  
AT Power Supply with Remote Feature
-   
AT Power Supply without Remote Feature  
(default)



***CPU to SRAM Data Transacting Mode Selection: SRAM***

This jumper allows you to select the CPU to SRAM data read/write mode. If you install a Cyrix or IBM processor on this motherboard, please set at 2-3 pin pair. Please also read Linear Burst feature of BIOS Setup, Page 36, Chapter 3 for more information.

-   
Intel Burst  
(default)  
For  
Intel, AMD,  
Cyrix,  
IBM CPUs
-   
Linear Burst  
For  
Cyrix,  
IBM CPUs

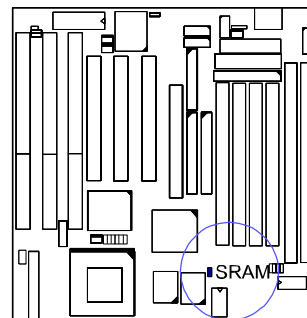

## 2). Install System RAM Modules

### RAM Module Configuration

SIMMs and DIMMs in Bank 0 and 1 can be installed in many combinations. Some of them are listed in the following table. Please note that SIMMs and DIMMs should not be installed at the same time.

(Unit : MB)

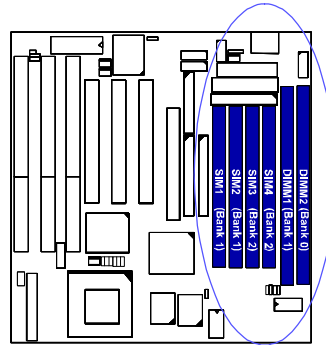

TOTAL MEMORY	SIMM1 & 2 (Bank 1)	SIMM3 & 4 (Bank2)	DIMM1 (Bank 1)	DIMM2 (Bank 0)
8	4 & 4			
			8	
16	8 & 8			
	4 & 4	4 & 4		
			16	
			8	8
32	16 & 16			
			32	
	8 & 8	8 & 8		
			16	16
64	32 & 32			
	16 & 16	16 & 16		
			64	
			32	32
128	64 & 64			
			64	64
256	128 & 128			
			128	128
512	128 & 128	128 & 128		

Installation Procedures

---

			256*	256*
--	--	--	------	------

**NOTE :**

1. \* A RAM module of this size was not available for testing at time of printing.
2. DIMM1 and 2 only support 3.3V (unbuffered) EDO/SDRAM modules.
3. DIMM1 and SIMM1&2 are shared. That is, it is not allowed to install RAM modules on DIMM1 and SIMM1&2 at the same time.
4. The different size of DIMM1 and DIMM2 is allowed. For example, 16MB is installed on DIMM1 socket, 32MB is installed on DIMM2 socket.
5. It is recommended that SIMMs and DIMMs are not installed at the same time on this motherboard to avoid unexpected failure.
6. This motherboard supports DIMMs with data access speeds of 10ns and 12ns; or faster.
7. This board supports SIMMs with access speeds of 70ns and 60ns.
8. If DIMM runs at 100MHz, it must meet the PC100 Specification.

### Install and Remove SIMMs

Complete the following procedures to install SIMMs:

**CAUTION :** Always turn the system power off before installing or removing any device; and see "Handling Precautions" at the start of this manual.

1. Locate the SIMM slots on the motherboard. (See figure below.)

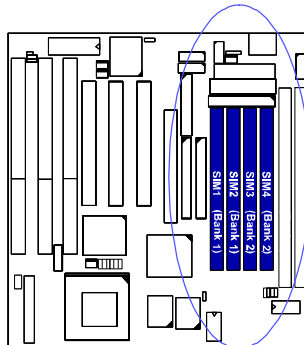

**NOTE :** SIMMs in each bank must be of the same type; and the BIOS automatically configures the memory size.

2. Carefully fit a SIMM at a 45 degree angle into each empty socket to be populated. All the SIMMs must face the same direction.



3. Swing each SIMM into its upright, locked position.  
When locking a SIMM in place, push on each end of the SIMM - do not push in the middle.

To remove the SIMMs, pull the retaining latch on both ends of the socket and reverse the procedure above.

### Install and Remove DIMMs

This motherboard supports 100 MHz SDRAM DIMMs; that is, the system frequency of this motherboard runs in a higher speed rather than the speed of 66 MHz.

Complete the following procedures to install DIMMs:

1. Locate the DIMM slots on the motherboard. (See figure below.)

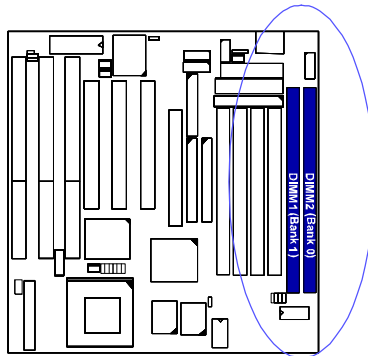

2. Install the DIMM straight down into the DIMM slot with both hands.
3. The clips of the slot will close up to hold the DIMM in place when the DIMM touches the slot bottom.

Press the clips with both hands to remove the DIMM.

**DIMM Frequency: CLK4,  
SDRAM1 &  
System Frequency: SDRAM2,  
SDRAM3**

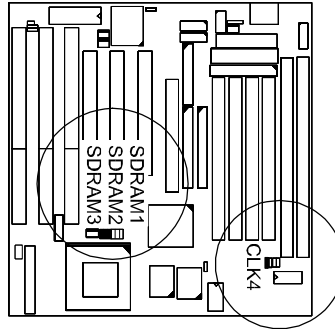

CPU External Freq.	DIMM Freq.	PC-100	Non PC-100	
		-6ns, -7ns, -8ns	-8ns, -10ns, -12ns, above	
100MHz				
83MHz			*	**
75MHz			*	**
66MHz			(Default)	

\* set for stable performance;  
\*\*set for high performance, but some SDRAM may make the system unstable.

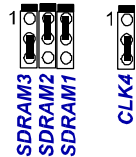
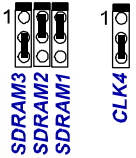
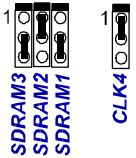
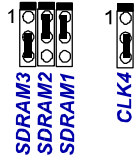
CPU External Freq. \ DIMM Freq.	PC-100 -6ns, -7ns, -8ns	Non PC-100 -8ns, -10ns, -12ns, above
124MHz	N/A	 SDRAM3 SDRAM2 SDRAM1 CLK4
112MHz	N/A	 SDRAM3 SDRAM2 SDRAM1 CLK4
95MHz	 SDRAM3 SDRAM2 SDRAM1 CLK4	 SDRAM3 SDRAM2 SDRAM1 CLK4

### Cache Memory

The VA-503+ comes with onboard 512KB (1MB is optional) synchronous 3.3V Pipeline Burst SRAMs. Cache memory access is very fast compared to main memory access. Since cache memory is from five to more than ten times faster than main memory, the system performance is better.

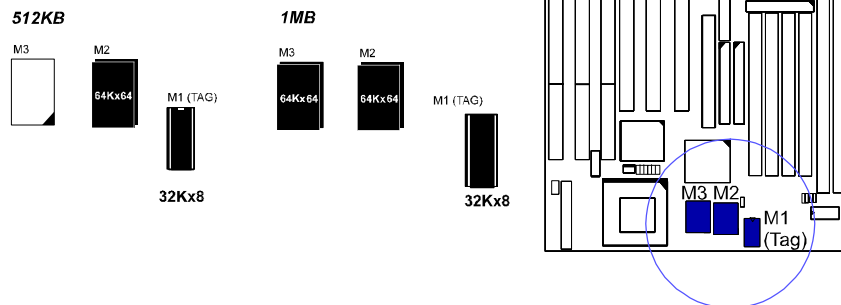

### 3). Install the CPU

The CPU module resides in the Zero Insertion Force (ZIF) socket on the motherboard.

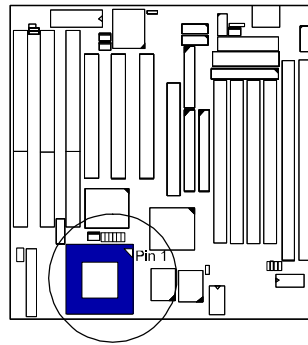

**CAUTION :**

1. Always turn the system power off before installing or removing any device.
2. Always observe static electricity precautions. See "Handling Precautions" at the start of this manual.
3. Inserting the CPU chip incorrectly may damage the chip.

To install the CPU, do the following:

1. Lift the lever on the side of the CPU socket.
2. Handle the chip by its edges and try not to touch any of the pins.
3. Place the CPU in the socket. The chip has a notch to correctly locate the chip. Align the notch with pin one of the socket. Pin one is located in the blank triangular area. Do not force the chip. The CPU should slide easily into the socket.
4. Swing the lever to the down position to lock the CPU in place.
5. See the following sections for information on the CPU jumpers settings.

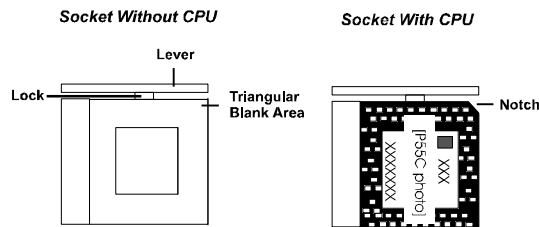

**CPU External (BUS) Frequency:  
CLK1, CLK2, CLK3**

The table below shows the jumper settings for the different CPU speed configurations.

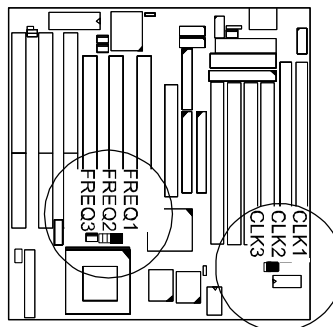

<p>124MHz*</p> <p>CLK3 CLK2 CLK1</p>	<p>112MHz*</p> <p>CLK3 CLK2 CLK1</p>	<p>100 MHz</p> <p>CLK3 CLK2 CLK1</p>	<p>75 MHz</p> <p>CLK3 CLK2 CLK1</p>
	<p>95MHz</p> <p>CLK3 CLK2 CLK1</p>	<p>83 MHz</p> <p>CLK3 CLK2 CLK1</p>	<p>66 MHz</p> <p>CLK3 CLK2 CLK1</p>

\* : When it selected, the system performance will not be guaranteed.

**CPU to Bus Frequency Ratio: FREQ1, FREQ2, FREQ3**

These three jumpers are used in combination to decide the ratio of the internal frequency of the CPU to the bus clock.

<p>2 x</p> <p>FREQ3 FREQ2 FREQ1</p>	<p>3 x</p> <p>FREQ3 FREQ2 FREQ1</p>	<p>4 x</p> <p>FREQ3 FREQ2 FREQ1</p>	<p>5 x</p> <p>FREQ3 FREQ2 FREQ1</p>
<p>2.5 x</p> <p>FREQ3 FREQ2 FREQ1</p>	<p>3.5 x</p> <p>FREQ3 FREQ2 FREQ1</p>	<p>4.5 x</p> <p>FREQ3 FREQ2 FREQ1</p>	<p>5.5 x</p> <p>FREQ3 FREQ2 FREQ1</p>

## Set CPU Frequency

### *Intel Pentium MMX*

Type	Freq.	Bus Freq.	Ratio
Pentium MMX	233	66	3.5 x
	200	66	3 x
	166	66	2.5 x

### *AMD-K6 (Unit of Freq. and Bus Freq. : MHz)*

Type	Freq.	Bus Freq.	Ratio
K6-300	300	66	4.5 x
K6-266	266	66	4 x
K6-233	233	66	3.5 x
K6-200	200	66	3 x
K6-166	166	66	2.5 x

### *AMD-K6-2-300/333/350/366/400 (Unit of Freq. and Bus Freq. : MHz)*

Type	Freq.	Bus Freq.	Ratio
K6-2-400	400	100	4 x**
K6-2-366	366	66	5.5 x**
K6-2-350	350	100	3.5 x**
K6-2-333	333	95	3.5 x
K6-2-300	300	66	4.5 x
		100	3 x

### *IBM/Cyrix 6x86L/6x86MX (Unit of Freq. and Bus Freq. : MHz)*

Type	Freq.	Bus Freq.	Ratio
6x86MX-PR266	233	83	2.5 x
6x86MX-PR233	200	83	2 x
		75	2.5 x
6x86MX-PR200	166	66	2.5 x
		75	2 x
6x86MX-PR166	150	66	2 x
6x86L-PR200+	150	75	2 x
6x86L-PR166+	133	66	2 x

**Cyrix M II-300/333/350, IBM 6x86MX-PR300/333/350**  
*(Unit of Freq. and Bus Freq. : MHz)*

Type	Freq.	Bus Freq.	Ratio
Cyrix M II-300	233	66	3.5 x
		75	3 x
IBM 6x86MX-PR300	233	66	3.5 x
Cyrix M II-333 IBM 6x86MX-PR333	250	83	3 x
Cyrix M II-350	300	100	3 x**
IBM 6x86MX-PR350	291	83	3.5 x**
	300	75	4 x**

\*\* this type of CPU was not available for testing at time of printing.

**NOTE :** Please refer to your CPU top marking about the actual CPU speed and ratio.

### Set CPU Voltage

This section lists all possible CPU voltages that this motherboard supports. There are three rows of CPU voltage (core voltage) jumper setting in the diagram below.

**NOTE :** Please refer to your CPU top marking about the actual CPU voltage.

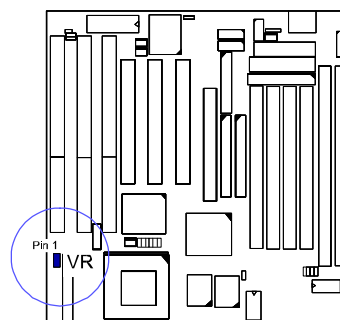
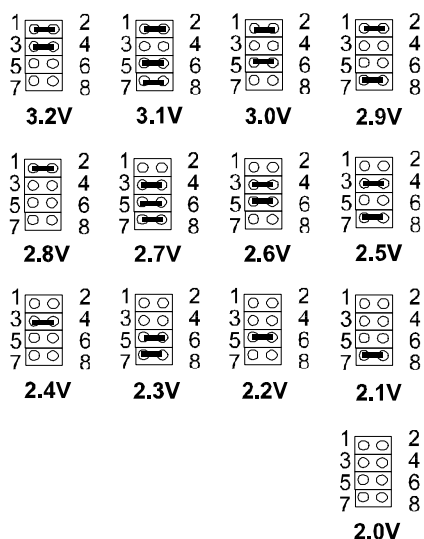

## 4). Install Expansion Cards

This section describes how to connect an expansion card to one of your system's expansion slots. Expansion cards are printed circuit boards that, when connected to the motherboard, increase the capabilities of your system. For example, expansion cards can provide video and sound capabilities.

Your VA-503+ features **one 32-bit AGP Bus, three 16-bit ISA Bus, and three 32-bit PCI Bus** expansion slots.

### CAUTION :

1. Always turn the system power off before installing or removing any device.
2. Always observe static electricity precautions. See "Handling Precautions" at the beginning of this manual.

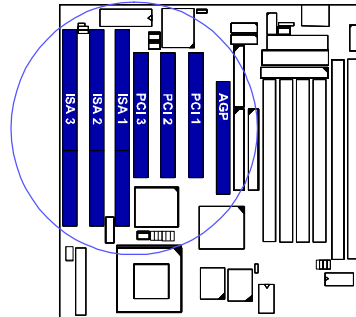

To install an expansion card, do the following:

1. Remove the chassis cover and select an empty expansion slot.
2. Remove the corresponding slot cover from the chassis.  
Unscrew the mounting screw that secures the slot cover and pull the slot cover out from the chassis. Keep the slot cover mounting screw nearby.
3. Holding the edge of the peripheral card, carefully align the edge connector with the expansion slot. (See figure below.)

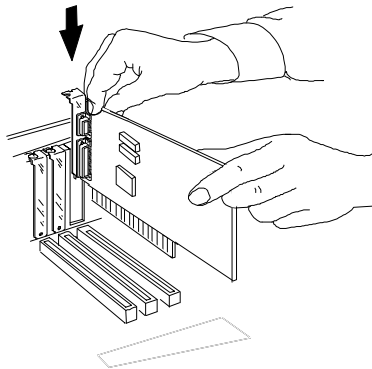

4. Push the card firmly into the slot. Push down on one end of the expansion card, then the other. Use this "locking" motion until the add-in card is firmly seated inside the slot.
5. Secure the board with the mounting screw removed in Step 2. Make sure that the card has been placed evenly and completely into the expansion slot.



## 5). Connect Cables and Power Supply

### **Keyboard Connector: AT\_KB**

The cable of your 101-key enhanced keyboard or 106-key Windows 95 keyboard is plugged into this connector.

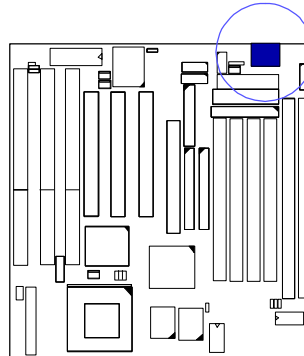
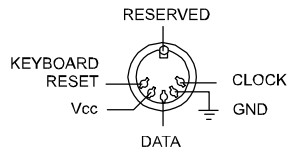

### **Serial Port Connectors: COM1, COM2**

These two connectors allow you to connect with your devices that take serial ports, such as a serial mouse or a modem. Usually, it is recommended to connect your serial mouse to COM1 and your fax/modem to COM2.

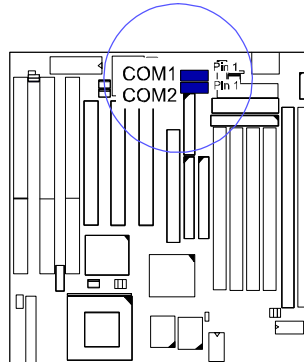

### **Universal Serial Bus Connector: JUSB**

This 2x5 connector links with USB peripheral devices via an optional USB riser card.

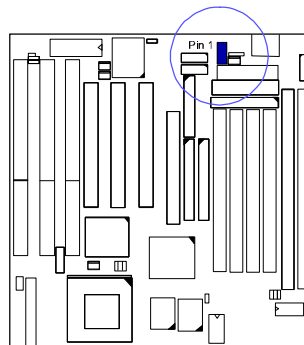
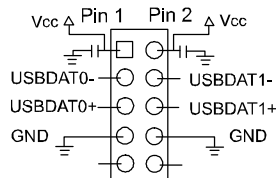

**CPU Fan Connector: CPU\_FAN**

This connector is linked to the standard CPU fan for cooling the CPU temperature. The EISCA CPU fans are also supported.

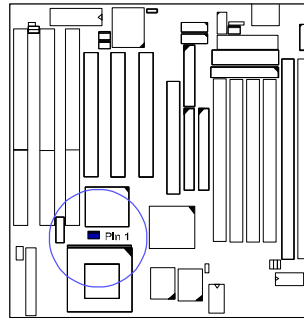
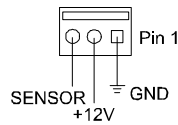

**EISCA CPU Fan Connector: EICA**

This 2x6 pinhead is for the EISCA CPU fan use. This type CPU fan is equipped with a thermal sensor for hardware monitoring. EISCA fan, a product of PENTALPHA International Inc., is recommended. The company phone: 011-886-2-86653248. Fax: 011-886-2-86653249. The web site is [www.pentalpha.com/pen](http://www.pentalpha.com/pen).

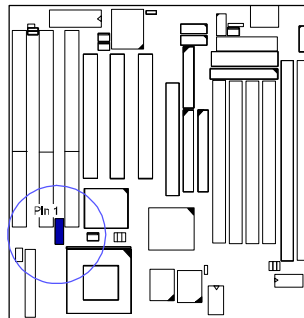
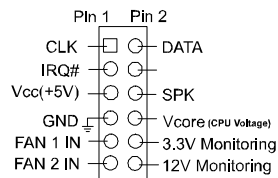

**Printer Connector: LPT**

This connector is featured onboard for the connection with your printer.

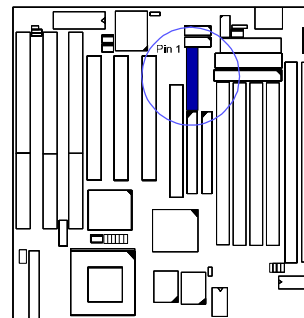

**Floppy Diskette Drive Connector: FDD**

This connector provides the connection with your floppy disk drive.

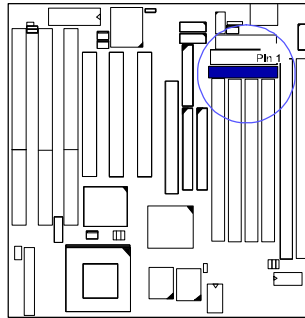

**Remote Power Connector: CN5**

This 3-pin connector allows you to enable (or disable) the system power if the RPW\_SW is on (or off) when an AT power supply is installed. Some of AT power supply come with a 3-pin plug, plug it on this connector. If you use an ATX power supply, ignore this connector. It allows soft power off in Windows 95.

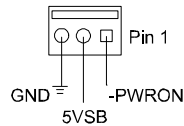
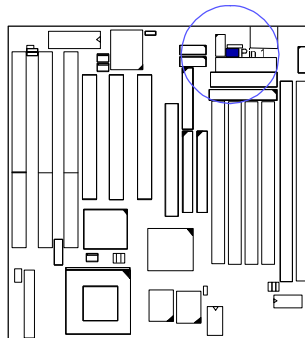

**IDE HDD Device Connectors:  
PRIMARY, SECONDARY**

These two connectors are used for your IDE hard disk drives, CD drives, LS-120 drives, or IDE ZIP drives.

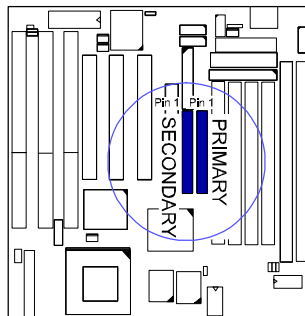

**PS/2 Mouse Connector: MS\_CON**

This connector is connected to the PS/2 mouse.

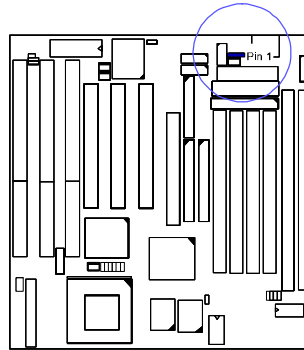
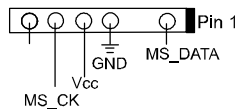

**Chassis Fan Connector: CHAS\_FAN**

This connector is for linking to your cooling fan on the system case to lower the temperature of the system. This connector also supports the fans with speed detection sensors.

Please read the chassis fan installation guide before connection.

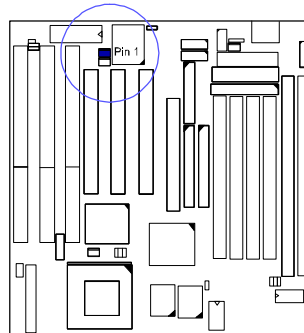
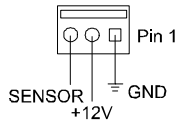

**Infrared Connector: IR**

This connector supports the connection to your IR device.

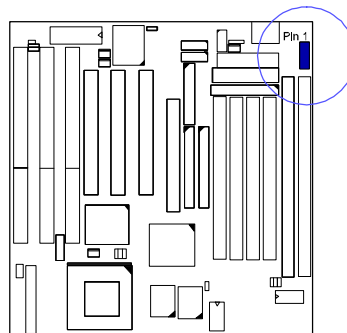
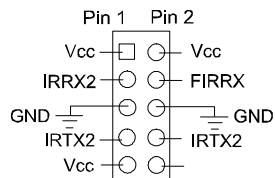

***Front Panel Block Connector: F\_PNL***

This block connector concludes: PW\_LED, KB\_LOCK, TB\_LED, SP\_SW, SPK, SP\_LED, IDE\_LED, RPW\_SW, and RST connectors.

Usually, the plugs with wires for above LEDs (indicators), speaker and switches come with the system case. Please identify polarities of plug wires for the case speaker and LEDs; that is, which wires are positive (+). Please ask vendor about this information when you buy them and install the system by yourself. The switches are called *Miniature Push Switches*. The plug wires' polarities of this switches will not affect the function.

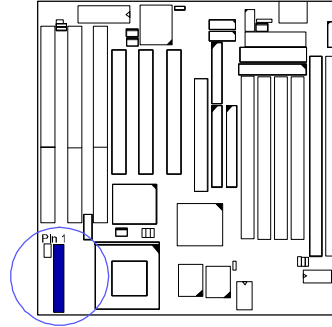

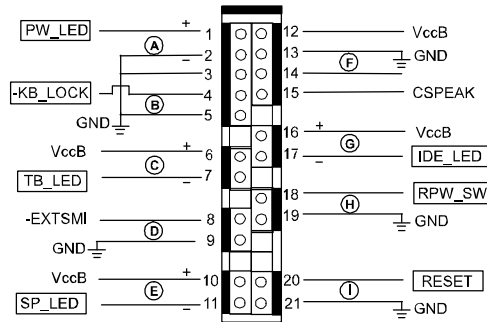

**Pinout Assignment**

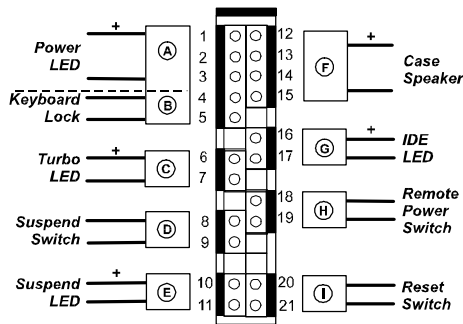

**Connection Diagram**

**PW\_LED (A) & KB\_LOCK (B)**

PW\_LED is connected with the system power indicator to indicate whether the system is on/off and the case-mounted keyboard lock to lock keyboard. KB\_LOCK prevents keyboard access to the system (this feature is used in combination with the case-mounted keylock).

**TB\_LED (C)** is connected with turbo indicator. It always lights.

**SP\_SW (D)** is connected with suspend mode switch.

**SP\_LED (E)** is connected with suspend mode indicator.

**SPK (F)** is connected with the case speaker.

**IDE\_LED (G)** is connected IDE device indicator. This LED will blink when the hard disk drives are activated.

**RPW\_SW (H)** is connected with remote power switch.

If an ATX power supply is installed, push this switch will turn on or off the system instead of turning the power switch on the power supply.

If an AT power supply is installed, the CN5 (Page 24) must be connected with this AT power supply to have the remote power on/off function by pushing this switch instead of turning the power switch on the power supply.

**RST (I)** is connected to the reset switch. Push this switch to reboot the system instead of turning power switch on and off.

***PS/2 Keyboard and Mouse Connector: KB, MS (manufacturing option)***

These two 6-pin female connectors are equipped for your PS/2 keyboard and PS/2 mouse.

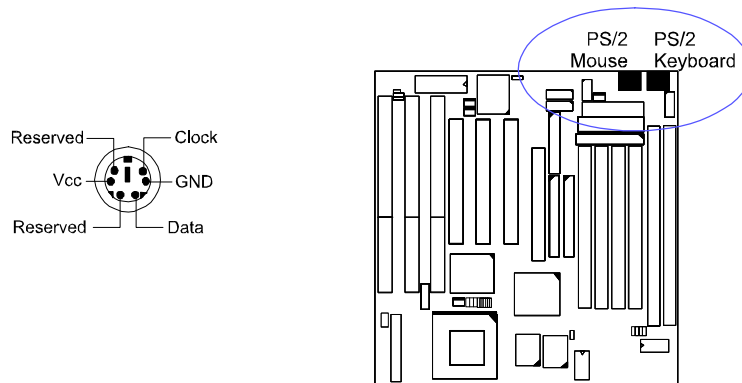

**NOTE:** If the PS/2 keyboard and PS/2 mouse connector were installed on the board. The AT\_KB connector in Page 22 and MS\_CON connector in Page 25 will not be equipped on this board.





This 3-pin connector allows LAN servers to manage the system that installed this board via network adapters support WOL. Please read the network card guide for details and Page 40 **Resume by Ring & LAN**.

